



Roadtrek™®

*The Motorhome that...
Drives like an SUV!™®*



Sprinter Models Owner's Manual

Including
Limited Warranty Information



WARNINGS AND CAUTIONS

This manual contains **WARNINGS** against operating procedures which could result in an accident or bodily injury.

The manual also contains **CAUTIONS** against procedures which could result in damage to your vehicle.

If you do not read the entire manual you may miss important information. Observe all Warnings & Cautions.

WARNINGS:

SEAT BELTS:

Only forward facing seats equipped with factory installed seat belts are to be occupied while the vehicle is in motion. All passengers must be seated in these seats only, with the seat belts fastened while the vehicle is in motion.

TV:

The flat screen TV should not be stored inside the Roadtrek in temperatures below -4°F, (-20°C) to reduce the chance of damage from the cold. The operating temperature of the monitor is recommended between 50°F and 104°F, (10°C and 40°C) with a humidity range of 10% to 80%, non condensing.

If your vehicle is equipped with an optional flat screen TV, the TV must be off and in the stored position during travel.

PROPANE:

Propane tanks shall not be placed or stored inside your vehicle. Propane tanks are equipped with safety devices which relieve excessive pressure by discharging gas to the atmosphere.

To reduce the danger of fire or explosion do not store gasoline or other flammable liquids inside your vehicle. Ensure that you purchase propane from a reputable propane facility. Contaminated propane is a common cause of system failure.

Do not refuel the propane tank to more than 80% of its capacity.

The propane tank valve must be closed and ALL PILOT LIGHTS, APPLIANCES, AND THEIR IGNITERS, (see Operating Instructions) SHALL BE TURNED OFF during refueling of the motor fuel tank and/or the propane fuel tank. Only qualified personnel should refuel your propane tank.

APPLIANCES:

It is not safe to use cooking appliances for space heating purposes due to the danger of asphyxiation.

The propane stove needs fresh air for its safe operation.

Portable fuel burning equipment, including wood or charcoal grills and stoves, should not be used inside your vehicle. Use of this type of equipment inside your vehicle may cause a fire or asphyxiation.

PROPANE LEAK DETECTOR:

Do not block the air circulation in the area where the Propane Leak Detector is located.

Battery disconnect switch must be in the "ON" position for the propane detector to function.

CARBON MONOXIDE LEAK DETECTOR:

Do not block the air circulation in the area where the carbon monoxide leak detector is located.

Battery disconnect switch must be in the "ON" position for the Carbon Monoxide Leak Detector to function.

110 VOLT ELECTRICAL SERVICING:

Prior to servicing the 110 volt Galley GFCI & Audio/Video cabinet interior receptacles, unplug the output lead from the power inverter.

EXTERIOR ACCESS DOORS:

Ensure power cord and city water line are disconnected and in their stored positions before the vehicle is put in motion.

CAUTIONS:

CLOVERLEAF DINING TABLE:

Cloverleaf dining table is heavy, bend knees while lifting.

EXTRA COUNTER SPACE:

Make sure the stove is off and has cooled prior to lowering the stove cover.

TV:

When the vehicle is in motion it is recommended that the TV be "OFF" and in the stored position.

The flat screen TV, (option TF) should not be stored inside the Roadtrek in temperatures below -4°F, (-20°C). The operating temperature of the monitor is recommended between 50°F & 104°F, (10°C – 40°C) with a humidity range of 10%-80%, non condensing.

To remove the T/V, remove the four mounting bolts on the back of the T/V mounting bracket and remove the RCA cables, power supply cable and antenna cable.

AUXILIARY BATTERY:

Battery acid can burn skin and clothing. Protective eye wear and gloves should be worn when handling batteries.

REPLACING THE AUXILIARY BATTERY:

Ensure that the inverter is disconnected prior to disconnecting the auxiliary battery.

GENERATOR:

When launching a boat using your Roadtrek, it is important to know that the generator **MUST NOT** be submerged in water. When using the generator as the main power source to run the appliances, refer to the generator owners manual for proper use and maintenance.

WASTE WATER STORAGE AND DUMPING SYSTEM:

Ensure that both the black and gray water gate valves are closed, (inward position) before using the waste water system.

Under moderate subfreezing conditions, antifreeze is required in the exterior fresh water tank, black and gray waste water tanks, water system should be winterized.

THE WARNINGS AND CAUTIONS IN THE QUICK REFERENCE ARE AN OVERVIEW AND THERE ARE MORE NOTES AND INSTRUCTIONS WITHIN THIS MANUAL.

OBTAINING MOTORHOME SERVICE

The solution to all your Roadtrek concerns starts with your Roadtrek Dealer

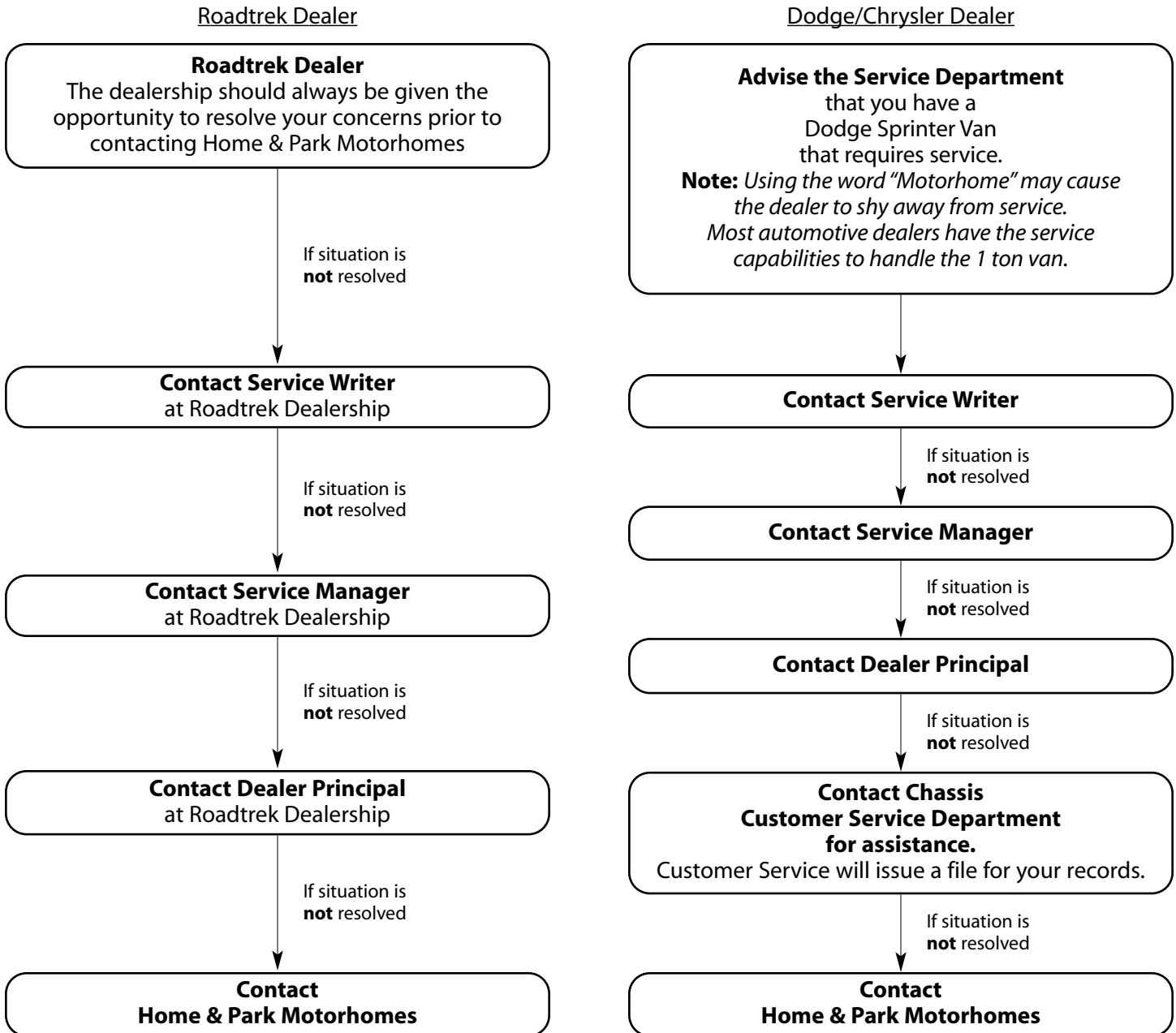

Introduction	A-1
Weight Ratings	A-2
Specifications, (Automotive/Motorhome)	A-3
Appliance Log	A-4
Manufacturer Contact Information	A-5
Daily Living	B-1
Captain's Seats	B-1
Seat Belt Usage	B-1
Cloverleaf Dining Table	B-2
Dinette Table	B-3
Sleeping Facilities	B-4
Rear Twin Beds	B-4
Rear King Bed	B-5
Front Lounge Seats	B-6
Washroom and Shower Area	B-7
Front and Rear Washroom Doors	B-7
Washroom Exhaust Fan	B-7
Washroom Facilities	B-8
Toilet	B-8
Permanent Bathroom Shower	B-8
Extra Counter Space	B-9
TV	B-9
Exterior Access Doors	B-10
Driver Side Access Doors	B-10
Propane Access Door	B-11
Rear Storage Area	B-11
Auxiliary Battery	B-12
Replacing the Auxiliary Battery	B-12
Spare Tire Storage	B-13
Caution Note, (Mineralling)	B-13
Signal Selection Switch	B-14
Audio/Video Cabinet	B-14
RSA Elevation Diagram	B-15
RSA Floorplan	B-16
Electrical System	E-1
Inverter/Charger	E-1
10V Inverter/Charger Shut Down	E-1
Inverter/Charger Start up After Automatic Safety Shut Down	E-1
Dry Camping Battery Conservation	E-1
Receptacle Functionality	E-1
12V DC/110V AC Inverter/Charger/Distribution Panel	E-2
External Electrical Source Connection	E-2
Generator	E-2
Monitor Panel	E-3
Auxiliary Battery and Battery Separator	E-4
Automotive Battery	E-4
Interior Cab Light	E-4
Water Heater	E-4
Rear Storage Light	E-4
Electrical System Legend	E-5
Electrical Distribution/Fuse Panel	E-6
Electrical System Schematic	E-7
Propane & Safety System	F-1
Propane Tank	F-1
Appliances	F-1
Refueling Procedures	F-2
Regulator	F-2
Propane Leak Detector	F-2
Carbon Monoxide Leak Detector	F-2
Smoke Detector	F-3
Propan System Diagram	F-4

Water Systems	G-1
Water Heater Bypass System	G-1
Fresh Water Tank Drain	G-1
To De-Winterize	G-1
Fresh Water Tank	G-2
Filling the Fresh Water Tank	G-2
City Water Connection	G-3
Waste Water Storage and Dumping System	G-4
Waste Water Tank Preparation	G-4
Waste Water Tank Dumping	G-5
Waste Water Tank Flushing	G-6
Outside Shower	G-6
Potable Water System Draining	G-6
Potable Water System Sanitizing	G-7
Water System Winterizing	G-7
Water Tank/System Location Diagram	G-8
Water Tank Top Down Diagram	G-9
Water Tanks Bottom Up Diagram	G-10
Tire Fundamentals	H-1
UTQGS Information	H-2
Owner Maintenance	I-1
Exterior Washing	I-1
Other Maintenance	I-1
Winter Storage	I-1
Inside Your Vehicle	I-1
Outside Your Vehicle	I-1
Spring Start-Up	I-2
Tires	I-2
Cargo Carrying Capacity	I-2
Owner Maintenance Checks	I-2
When You Stop for Fuel	I-2
At Least Monthly	I-2
At Least Once Every Three Months	I-2
At Least Twice A Year	I-3
At Least Once A Year	I-3
Auxiliary Battery	I-3
Aluminum Wheel Maintenance	I-4
Limited Warranty Information	J-1
Limited Warranty Definitions	J-1
Home & Park Limited Warranty Registration	J-1
Automotive Warranty - DaimlerChrysler, (Dodge Sprinter Chassis)	J-1 - J-2
Automotive Customer Service & Roadside Assistance Numbers	J-2
Appliance Warranty	J-2
Home & Park Limited Motorhome Warranty	J-3 - J-4
Customer Assistance	K-1
Reporting Safety Defects, (U.S. Only)	K-1
Roadtrek Ambassador Potential Customer Referral Program for Roadtrek Owners	K-1
Roadtrek Club International	K-2
Address, Phone & Facsimile Numbers, and E-mail	K-2
Website	K-2
Roadtrek International Chapter FMCA / A Roadtrek Owners' Club Membership Forms	L-1
Change of Owner Name or Address Form	M-1 - M-2
Potential Customer Referral Card	M-3 - M-4

A WORD TO ROADTREK OWNERS...

This manual has been prepared to acquaint you with the operation, maintenance and warranties of your new **Roadtrek Motorhome Van**. Your vehicle has been designed, engineered and manufactured to provide you with the utmost in pleasure, dependability and quality. **It is important that you read the contents of this manual**, that of the Dodge chassis and those of other components, and follow the instructions and recommendations contained in each to help assure the most enjoyable and trouble free operation of your vehicle.

We would like to take this opportunity to thank you for selecting a **Roadtrek** product, and assure you of our continuing commitment to your recreational vehicle pleasure, safety and satisfaction.

INTRODUCTION

This manual has been written to provide you with the information required to properly operate and maintain your new Roadtrek. After reading this manual, be sure to keep it in your vehicle as a reference. Your **Roadtrek** dealer will be glad to answer any further questions about the operation of your vehicle.

IMPORTANT

Every reasonable precaution has been undertaken in the preparation of this manual resulting in the utmost accuracy possible at the time of publication. However, due to the continuing improvement and refinement of our products and normal changes in information and procedures, Home & Park shall assume no responsibility whatsoever for errors or omissions in the manual's contents.

Further, Home & Park shall not be held liable or assume any obligations or responsibilities whatsoever for any loss, damage or injury directly or indirectly caused by, arising or resulting from, or as a consequence of the use or nonuse of the information contained herein or the operation or non-operation of any items mentioned herein. And finally, Home & Park shall be indemnified and saved harmless from all losses, expenses, claims and demands whatsoever.

Weight Ratings

Gross Vehicle Weight Rating, (GVWR): is the maximum permissible weight of this vehicle when fully loaded. It includes all weight at the vehicle axle(s).

Unloaded Vehicle Weight, (UVW): is the weight of this motorhome as manufactured at the factory. It includes all weight at the vehicle axle(s). If applicable, it also includes full generator fluids, including fuel, engine oil and coolants.

Cargo Carrying Capacity, (CCC): is equal to GVWR minus each of the following: UVW, full fresh, (potable) water weight, (including water heater), and full propane weight and SCWR.

Gross Combined Weight Rating, (GCWR): means the maximum allowable loaded weight of this motorhome and any towed trailer or towed vehicle.

Canadian Models - Seating Capacity Weight Rating, (SCWR)
US Models - Sleeping Capacity Weight Rating, (SCWR): is the manufacturer's designated number of sleeping positions multiplied by 154 pounds, (70 kilograms).

Gross Axle Weight Rating, (GAWR): is the value specified as the load carrying capacity of a single axle system, as measured at the tire-ground interfaces.

Towing Guidelines: Consult Dodge Sprinter Owners Manual(s) for specific weighing instructions and towing guidelines, including auxiliary brake requirements for any towed trailer or towed vehicle.

Weighing Procedure: Prior to weighing each unit, the fuel tank must be full, as well as the fresh water tank. All tires must be of equal pressure, and any snow must be removed.

Note: the weighing must be done on level ground!

Equipment: 2 Portable Scales, (including electrical power source), 2 wooden ramps, lift and pressure gauge.

Alternate: D.O.T. approved customer scales.

Note: Wooden ramps must be equal to or less than 1/8" of the height of the scales being used.

Procedure:

- 1) Fill Fuel Tank.
- 2) Fill Fresh Water Tank.
- 3) Measure all tire pressures and equalize if necessary.
- 4) Place wooden ramps below rear wheels, (using lift or driving onto ramps for levelling vehicle; N/A if commercial scales used).
- 5) Place scales under front wheels.
- 6) Record scale readings.
- 7) Repeat for rear wheels.

VIN: 1GBHG31U1 31205833 MANUFACTURED BY:

MOTORHOME WEIGHT INFORMATION

GCWR(GROSS COMBINED WT RATING): THE MAX. ALLOWABLE LOADED WT OF THIS MOTORHOME & ANY TOWED TRAILER OR TOWED VEHICLE
 UNLV (UNLOADED VEHICLE WT): THE WT OF MOTORHOME AS MANUFACTURED AT THE FACTORY WITH FULL FUEL, ENGINE OIL & COOLANTS
 SCWR (SLEEPING CAPACITY WT RATING): THE MANUFACTURER'S DESIGNATED No. OF SLEEPING POSITIONS X 154 POUNDS (70 KILOGRAMS)
 CCC (CARGO CARRYING CAPACITY): = GVWR - (UVW+FULL FRESH(POTABLE) WATER WT(INCLUDING HOT WATER)+FULL LP-GAS WT+ SCWR)

GVWR	9600	4354
MINUS UVW	7570	3454
MINUS FRESH & HW WT (32 + 6) GALLONS @ 8.3 lb/gal	317	144
MINUS LP-GAS WT OF 9.8 GALLONS @ 4.5 lb/gal	42	19
MINUS SCWR OF 3 PERSONS @ 154 lb/person	462	210
MINUS TOTAL FACTORY SUPPLIED OPTION WT	271	123
CCC FOR THIS MOTORHOME	938	426

FRONT	4100 lb (1860 kg)	LT245/75R16-E	16 x 6.5J	50 PSI (340 KPA)	<input checked="" type="checkbox"/>
REAR	6084 lb (2760 kg)	LT245/75R16-E	16 x 6.5J	80 PSI (550 KPA)	<input checked="" type="checkbox"/>

TYPE OF VEHICLE: MPV CLASS B MOTORHOME SO 63145 Manufactured 16-Oct-03
 THIS VEHICLE CONFORMS TO ALL APPLICABLE U.S. FEDERAL MOTOR VEHICLE SAFETY STANDARDS IN EFFECT AS OF: 16-Oct-03

Paint Identification: Chassis Paint Code: 50UWAU8624 Deluxe Paint Code: MM203.50

Sample of US Weight label:

MANUFACTURED BY / FABRIQUE PAR: HOME & PARK MOTORHOMES Date: 23 Jul 03
 INCOMPLETE VEHICLE MANUFACTURED BY/VEHICULE INCOMPLÉTE CONSTRUIT PAR: GENERAL MOTORS CORPORATION Date: 01-Jan-03

GVWR/PNBV: 4355 Kg VIN/NIV: 1GBHG31U2 31163155

SEATING CAPACITY / NOMBRE DÉSIGNÉ DE PLACES ASSISSES: (3 x 70) = 210 Kg

GAWR/PMBE (KG)	TIRE/PNEU	RIM/JANTE	COLD INFL. PRESS. / PRESS. DE GONFL. À FROID
FRONT 1860	LT245/75R16-E	16 x 6.5J	50 PSILPC 340 KPA
REAR 2760	LT245/75R16-E	16 x 6.5J	80 550

CARGO CAPACITY	500 (kg)	CAPACITÉ DE CHARGEMENT	500 (kg)
CALCULATED WITH FRESH WATER TANKS FULL (COLD)	121 (kg)	(FROID)	121 (kg)
(HOT)	23 (kg)	(CHAUD)	23 (kg)
AND THE WASTE WATER TANKS EMPTY		ET LES RÉSERVOIRS D'EAUX USÉES VIDES	
WASTE WATER TANKS CAPACITY	182 (kg)	CAP. DES RÉSERVOIRS D'EAUX USÉES	182 (kg)

Paint Identification: Chassis Paint Code: 50UWAU8624 Deluxe Paint Code: B.M.W.442

Sample of Canadian Weight label:

2005 Standard Automotive Features	RS models on Dodge Sprinter 2500 Van
-----------------------------------	--------------------------------------

Air bag - driver & passenger	standard
Alternator	150 amp.
Axle - rear	3.72 ratio
Battery	760 amp.
Brakes - anti lock, (ABS)	four wheel disc
Bumper covers	standard, front only
Cooling - transmission oil	external
Cruise control	standard
Defroster - rear window	standard
Door locks - with remote	power - all doors, single key
Doors & exits	sliding side & 50/50 rear
Engine	Mercedes 2.7 L CDI 5 cyl. turbo diesel
Fuel capacity	100 L/26 US gal.
Mirror - interior	standard
Mirrors - exterior	power, heated w/aux. parabolic mirrors
Power	115 kW/154 HP
Seats - cab - Captain's	swiveling, height adjustable, manual lumbar support & dual armrests
Sound system	AM/FM & CD
Stability program - electronic	standard, (ESP)
Tire storage - spare	below floor at rear
Tires	LT225/75R16E black wall
Torque	330 N-m/243 lb-ft
Towing - GCWR *	6146 Kg/13550 lbs. *
Towing - tow weight **	2268 Kg/5000 lbs. **
Towing - tongue weight ***	227 Kg/500 lbs. ***
Traction control	standard
Wheels - steel	16" - with trim
Window operation	power - front doors only
Window tint	deep tinted

* Gross Combination Weight Rating, (GCWR) includes total weight of vehicle, equipment, fuel, water, propane, cargo, driver and passengers.

** Maximum towable weight with driver only. This weight reduced by weight of optional equipment, fuel, water, propane, cargo and/or passengers.

*** A weight distributing hitch is required for tongue weights over 200 Kg/400 lbs.

2005 Automotive Options	RS Dodge Sprinter Models
-------------------------	--------------------------

Receiver	class III
SE package	silver paint w/charcoal lower body, unique striping & dash trim
Seats - 2nd row - Captain's	swiveling, manual lumbar support & dual armrests
Seats - leather	captain's &/or lounge seats
Wheels - aluminum	16" - with steel spare
Wiring harness for towing - 7 way	includes 4 way

2005 Exterior Dimensions	RS Dodge Sprinter Models
--------------------------	--------------------------

Length	6680 mm/21' 11"
Height - overall	870 mm/ 9' 5", (with roof A/C)
Width - overall, (w/o mirrors)	1930 mm/ 6' 4"
Wheel base	4010 mm/158"
Unloaded vehicle weight **, (no opt.)	3000 Kg/6600 lbs.
Gross vehicle weight rating	3878 Kg/8550 lbs..

* Add 250 mm/10" if equipped with optional Continental spare tire kit.

** Includes weight of base vehicle and fuel only. Does not include weight of optional equipment, water, propane, cargo and/or passengers.

2005 Interior Dimensions	RS Dodge Sprinter Models
--------------------------	--------------------------

Standing height	1855 mm/73"
Rear king bed length	1930 mm/76"
Rear king bed width	1730 mm/68"
Rear twin bed length - left, right	1930 mm/76"
Rear twin bed width	710 mm/28"
Front single bed length - left, right	1830 mm/72", 1930 mm/76", (opt.)
Front single bed width	510 mm/20", (opt.)
Water tank - fresh	115 L/30 US gal.
Water tank - grey	91 L/24 US gal.
Water tank - black	40 L/10 US gal.

2005 Standard Motorhome Features	RS models on Dodge Sprinter 2500 Van
----------------------------------	--------------------------------------

Aisle	28"/710 mm wide
Bathroom/privacy area	permanently enclosed with vanity sink, mirror, sit-down & stand-up shower
Battery - auxiliary - 12V	lead acid deep cycle, 95 amp-hrs.
Battery storage - auxiliary	below floor
Beds - dual density foam	130 mm/5"
Carpet	40 oz. 100% Dupont nylon
Connection - auxiliary	LPG for BBQ w/quick disconnect
Connection - external - 110V	standard
Connection - external - TV cable	standard
Connection - external - water	standard with quick disconnect
Counter top	solid surface
Detectors	smoke, propane & CO
Faucet - galley	single lever
Furnace - 'Suburban'	propane automatic, 16000 BTU for propane 'Onan'
Generator ready package	convection, 26L/0.9 cu.ft., 1800 W
Convection/Microwave oven - 110V	water & propane levels, battery charge & battery disconnect
Monitor panel	12/110V, 750W, w/3 step 45 amp. charger, (w/remote on/off switch)
Refrigerator - 'Dometic'	12V/110V/propane, 3.8 cu.ft.
Roof vent - 'FanTastic' - 12V	low profile power w/thermostat
Sewage disposal system	12V macerator sewage pump
Shower	sit-down or stand-up in bathroom
Sink	stainless steel w/flush cover
Storage area	across the rear
Storage capacity	55 cu.ft.
Storage compartments - exterior	1 below floor
Stove - two burner	propane with stainless steel cover
Table - dining - cloverleaf	32" x 32" open, 20" x 20" closed
Tank - propane	45 L/12 US gal./50 lbs.
Toilet - 'Thetford'	marine with foot pedal flush
Water fill - fresh - location	behind sliding door to reduce clutter & prevent tampering w/supply
Water heater - 'Suburban'	propane with bypass
	23L/6 US gal., 12000 BTU
Water system - on demand	12V with 'Shurflo' water pump
Water tank capacities	see Interior Dimensions
Windows	frameless awning type

2005 Motorhome Options	RS Dodge Sprinter Models
------------------------	--------------------------

Air conditioner - 110V	'Coleman' roof mount with electrical heat strip, 9100 BTU
Awning - box - 'Fiamma'	4000 mm/13'2"
Armoire - with adjustable shelves & drawers	interchangeable with right lounge seat (not available with 2 nd row captain seats)
Battery - second auxiliary	two lead acid deep cycle, 6V 220 total amp-hrs, (repl. 12V)
Coffee maker	110V
DVD player	110V with remote
Generator - 'Onan MicroLite'	propane, remote-start, 2.5 kW
Mattresses - folding	for front lounge or captain's seats
Pantry - hanging	beside stove
TV - flat screen	17" with remote
TV antenna	'Winegard' crank up
Video cassette recorder	110V with remote

APPLIANCE & ACCESSORY MANUFACTURER'S LOG

Appliance	Manufacturer	Model
Awning	Fiamma	F45
Battery - Auxiliary	Trojan	27TM
Battery - Auxiliary -Optional Dual	Trojan	T-605
Battery Separator	Sure Power	1315-200
CO Detector	MTI Industries	60-541
Coffee Maker	Black & Decker	ODC425
Distribution Panel	Progressive Dynamics	PD50K3Q2GP
DVD Player	RCA	DRC108N
Fire Extinguisher	Company Kidde	Elite 10
Furnace	Suburban	NT 16SE
Generator	Onan	Microlite
Heat Pump / Air Conditioner	Dometic	9201D876
Inverter	Tripp-Lite	RV750ULHW
Propane Detector	Electro Systems	GS/3
Propane Tank	Manchester	68001
Macerator Pump	Shur-Flo	3200-200
Convection/Microwave oven	Apollo	AAC24BIB
Monitor Panel	Kib	K46RT
Power Roof Vent	Fantastic	4000BT
Refrigerator	Dometic	RM2454R
Running Board Lock	Briggs & Stratton	702852 AB1
Smoke Detector	Fire Sentry	0914CA
Stove	Elmel	SD2 Proprietary
Toilet	Thetford	Aqua Magic IV Lo
Transfer Switch	Progressive Dynamics	PD5110610
TV	Samsung, (Flat Screen)	710MP
TV Antenna	Wine Gaurd	RV-7005
Water Heater	Suburban	SW6D
Water Pump	Shurflo	2088-403-144

Appliance manufacturers and model numbers subject to change without notice.

MANUFACTURER CONTACT INFORMATION:

Component	Manufacturer	Location	Phone Number
Awning	Fiamma	Orlando, FL	407-672-0091
Detector-carbon monoxide	MTI Industries	Wauconda, IL	800-383-0269, 847-487-4940
Detector - Propane	MTI Industries	Wauconda, IL	800-383-0269, 487-487-4940
Flat LCD T.V.	Aralex Acoustics Ltd	Coquitlam, BC	306-221-7610
Furnace, (U.S.)	Suburban Mfg.	Elkhart, IN	423-775-2131
Furnace, (Canada)	Suburban c/o GL Products	Oakville, ON	905-845-7558
Generator, (U.S.)	Onan Corporation	Minneapolis, MN	800-888-6626
Generator, (Canada)	Onan Corporation	Oakville, ON	905-795-0050
Heat Pump / Air Conditioner	Dometic	Elkart, IN	800-544-4881
Inverter/Charger	Tripp-Lite	Chicago, IL	773-869-1234
Propane Tank	Manchester		800-640-6327
Microwave, (U.S.)	Apollo		
Microwave, (Canada)	Apollo		
Oven-Microwave, (210)	Camco Inc.	Hamilton, ON	800-361-3400
Refrigerator, (U.S.)	Dometic Corporation	Elkhart, IN	800-544-4881, 219-463-4858
Refrigerator, (Canada)	Dometic Distribution	Cambridge, ON	519-653-4390
Roof Vent - Power	FanTastic Vent	Capac, MI	810-724-3818
Toilet, (U.S.)	Thetford Corporation	Ann Arbor, MI	800-521-3032
Toilet, (Canada)	Thetford Sanitation	Mississauga, ON	905-671-0255
TV Antenna	Winegard		800-288-8094
Water Heater, (U.S.)	Suburban Mfg.	Elkhart, IN	423-775-2131
Water Heater, (Canada)	Suburban c/o GL Products	Oakville, ON	905-845-7558
Water Pump, (U.S.)	Shurflo	Santa Ana, CA	800-854-3218
Water Pump, (Canada)	Shurflo	Belmont, ON	519-727-6752

CAPTAIN'S SEATS:

To recline, pull up the recline control lever below the inboard armrest and lean back.

To slide, pull up on the slide bar located on the front of the seat and slide the seat either forward or back, (see Picture B-P1a).

To swivel the seats from a forward facing position to a rearward facing position pull the swivel lever up, (see Picture B-P1).

Important Note: Before swiveling the seat, you must be aware of the following:

1. Ensure that the back of the seat is reclined forward, as far as the recline control allows.
2. Slide the seat forward, but not so far as to lose clearance of the engine cover. Pull up on the slide bar, (see Picture B-P1A).
3. The swivel lever is located on the front of the seat and locks the seat in a forward facing position. To release pull the swivel lever up and the seat freely swivels, (see location on Picture B-P1).
4. Swivel the seat to the desired position, (see Picture B-P2).

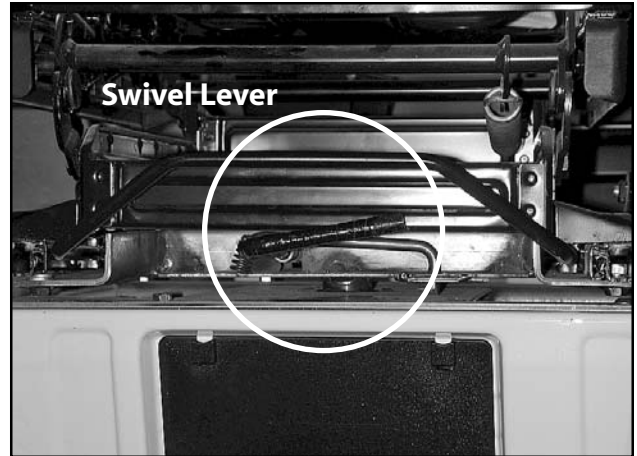

Picture B-P1: View of front captain's seat showing the location of the swivel lever.

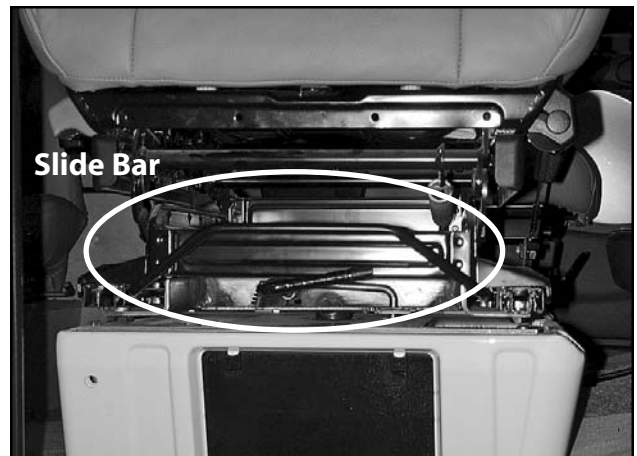

Picture B-P1A: View of the front of the Captain's seat, showing the location of the slide bar.



Picture B-P2: Captain seats swiveled towards the rear of the Motorhome.

SEAT BELT USAGE:

Only forward facing seats equipped with factory installed seat belts are to be occupied while the vehicle is in motion. All passengers must be seated in these seats only, with the seat belts fastened while the vehicle is in motion.

CLOVERLEAF DINING TABLE:

The cloverleaf dining table is stored behind the driver side lounge seat, (see Picture B-P3). Remove table leg from under the rear passenger bench seat, (see Picture B-P4) and place it in the floor base receptacle located in front of the lower galley cabinet. Place table top on top of table leg.

To use the table "leaves":

1. Pivot the table into the desired position.
2. In the seated position, with one hand on the top of the table, use the other hand to unfold the desired leaf to the upright position.

To return the "leaf" to its original position, use the following steps:

1. Hold the leaf with one hand.
2. With the other hand reach under the table and carefully press on the center of the downward facing part of the spring hinge.
3. Fold the leaf back into the stored position.

Caution: Cloverleaf dining table is heavy, bend knees while lifting.



Picture B-P3: Lower galley cabinet showing location of cloverleaf table, (stored position).



Picture B-P4: Cloverleaf and dinette table legs in the stored position, located in the aisle under the bed on the passenger side.

DINETTE TABLE:

Remove the table leg and place it in the floor base receptacle located in the aisle way at the rear on the floor. The table top is stored under the driver side rear bed cushion, (see Picture B-P6). Place table top on table leg, (see Picture B-P5).

When returning table top to the storage position ensure the table base is placed correctly in the table base receptacle located on top of the rear driver side bench, (see Picture B-P6). Return table leg to the storage clip in the aisle way, (see Picture B-P4).

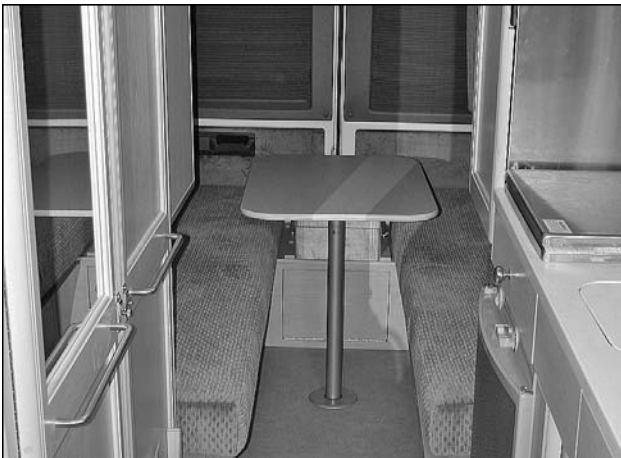

Picture B-P5: Location of assembled dinette table.

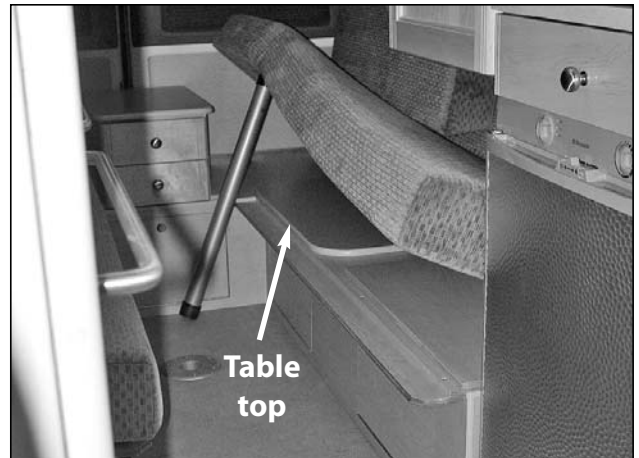

Picture B-P6: Location of dinette table, (stored position).

SLEEPING FACILITIES:

REAR TWIN BEDS

To convert the dinette into twin beds:

1. Remove the table and leg from its receptacle and place the table under the driver side seat cushion and store table leg.
2. Place both back rest cushions on the floor vertically up against the seat base boxes or store if desired.
3. Pull each seat cushion 3", (8 cm) from the wall to provide additional elbow room while sleeping.
4. Night table can be removed, (see Picture B-P7) and stored if desired.

To convert back to a dinette, perform these steps in reverse order.

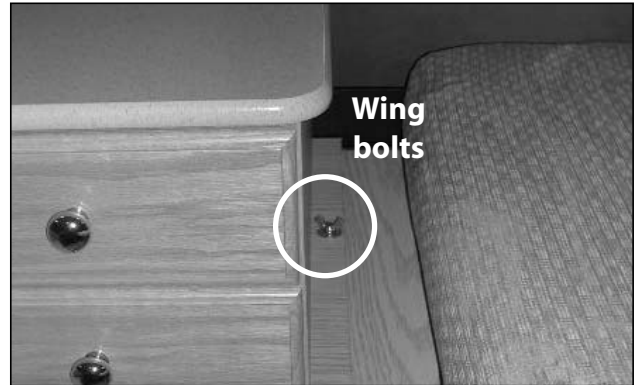

Picture B-P7: Wing bolts attaching the night table, are accessed from the sides of the night table as illustrated above.



Picture B-P8: Placement of the cushions for Twin beds.

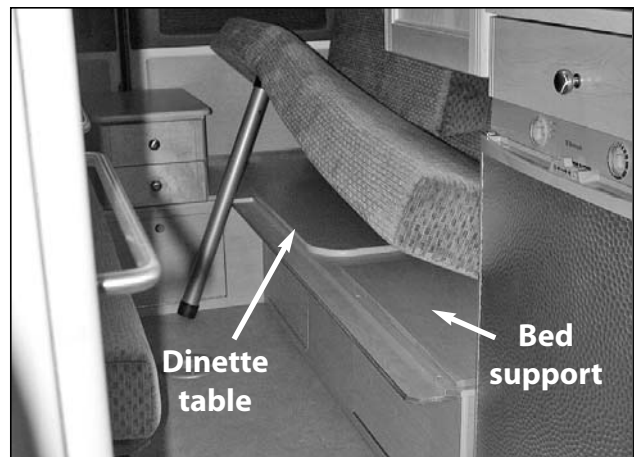

Picture B-P9: Storage location of dinette table and bed support for King size bed.

REAR KING SIZE BED:

To convert the dinette into a King size bed:

1. Remove the table and leg from its receptacle.
2. Remove night table and store. In order to remove the night table, unscrew the wing bolt found on each side of the night table, (see Picture B-P7). Store the wing bolts in the night table drawer when not in use.
3. Place the table top on supports in the aisle, (see Picture B-P10).
4. Remove the bed support from storage located under the bed cushion on the driver side, (see Picture B-P9).
5. Install bed support, (see Picture B-P10).
6. Place both back rest cushions together in the center of the bed, (see Picture BP-11).
8. Install filler cushion on the passenger side of the bed, (see Picture B-P13).

To convert back to a dinette, perform these steps in reverse order.



Picture B-P10: Placement of the table top and the wood support for the king size bed.



Picture B-P11: Lay cushions flat.

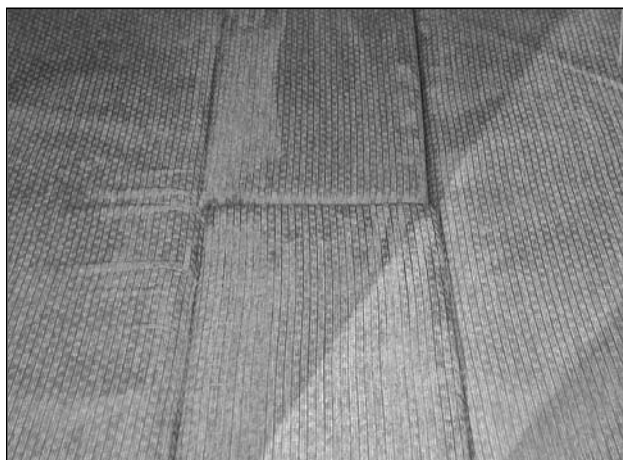

Picture B-P12: Placement of the back rest cushions.



Picture B-P13: Placement of the filler cushion.

FRONT LOUNGE SEATS:

Adjustment of the lounge seat:

1. To swivel the lounge seat, pull back on the swivel handle and turn the seat, (see Picture B-P14).
2. To slide the lounge seat forward or back, pull up on the slide adjustment handle and slide, (see Picture B-P15).
3. To adjust the arm rest, turn the adjustment screw under the arm rest, (see Picture BP16).
4. The fresh water gravity fill is located on the out board side of the passenger side lounge seat, (see Picture B-P17).

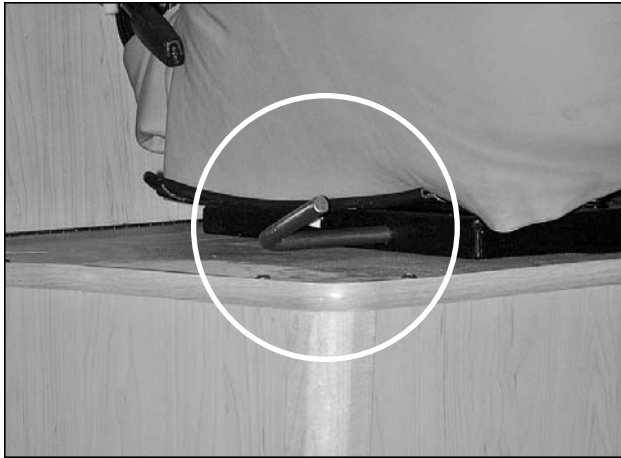

Picture B-P14: Swivel lever handle.

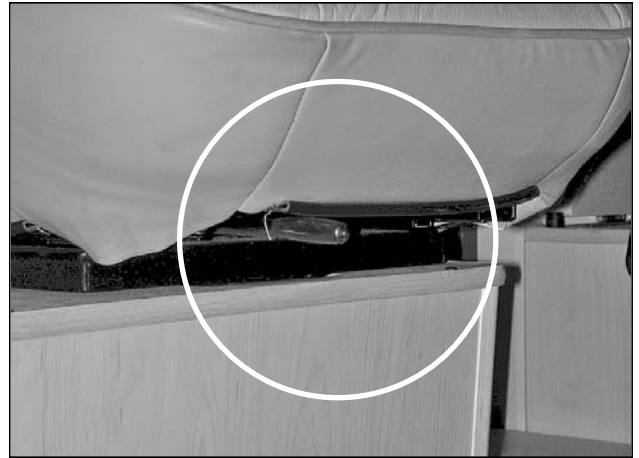

Picture B-P15: Slide adjustment handle.



Picture B-P16: Arm rest adjustment screw.

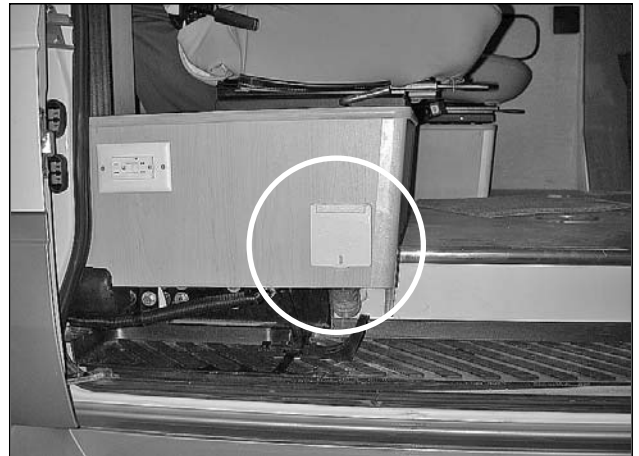

Picture B-P17: Location of the fresh water gravity fill.

WASHROOM AND SHOWER AREA:

FRONT AND REAR WASHROOM DOORS:

Rear washroom door:

1. To open the rear washroom door loosen the thumb screw and lift the door latch and pull, (see Picture B-P18).

Front washroom door:

1. To open the front washroom door lift the, (in transit) locking pin and turn the pin towards the aisle, (see Picture B-P21).
2. Be sure to have the rear washroom door open first.
3. Pull door open.

Washroom exhaust fan:

1. To open the washroom exhaust vent, push up on the vent handle, (see picture B-P20).
2. To turn on the washroom exhaust vent, turn the on switch clockwise to the "ON" position, (see Picture B-P20).



Picture B-P18: Washroom, (in transit) door latch.

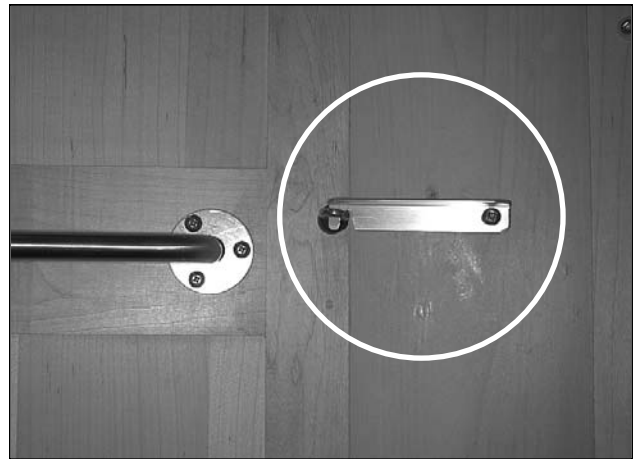

Picture B-P19: Inside shower door latch.



Picture B-P20: Bathroom exhaust vent.

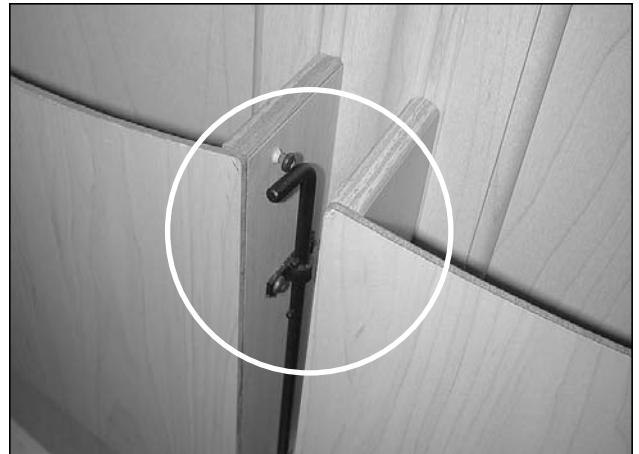

Picture B-P21: Front bathroom door, (in transit) locking pin in the locked position.

WASHROOM FACILITIES:**TOILET:**

1. Privacy is achieved by closing both bathroom doors.
2. The washroom is equipped with an exhaust vent, (see Picture B-P20).

PERMANENT BATHROOM SHOWER:

To set up the bathroom shower:

1. Remove floor drain plug from floor, (see Picture P-B22).
2. Privacy is achieved by closing both doors and securing them using the inside shower door latch, (see Picture B-P19).
3. Install the shower hose on the bathroom faucet. Place the shower head in the, (in use) holder, (see Picture B-P23).
4. Draw the shower curtain until you have covered the bathroom doors.
5. Using the Velcro connectors, secure the edges of the curtain to the shower interior walls.
6. When adjusting the water temperature, be sure to allow enough time for the temperature adjusted water to exit the shower head before making further adjustments.
7. The bathroom exhaust vent may be used to remove steam and moisture.

To put away the stand-up shower:

1. Rinse and dry the shower curtain thoroughly, (this function is most easily performed before leaving the shower area after use).
2. Allow the curtain to air dry completely, (this function can be expedited using the power roof vent or the bathroom vent).
3. Replace floor drain plug when finished.

To prevent grey water tank contents from spilling onto the floor while driving, keep the drain plug secured when not in use.



Picture B-P22: Location of permanent bathroom shower drain.



Picture B-P23: Shower head location while in use.



Picture B-P24: Storage drawers in bathroom vanity.

EXTRA COUNTER SPACE:

In order to provide additional counter space, your motorhome has the following two features:

1. Stove top cover.
2. Sink cover, (cutting board).

To raise the stove cover do the following:

1. The stove cover is fit so you just need to lift and lean back on the support arm located on the left hand side of the stove top cover, (see Picture BP25).
2. Raise cover while cooking, when finished lower stove cover.

CAUTION: Make sure the stove is off and has cooled prior to lowering stove cover.

TV:

To view the flat screen display, swing the screen on its base to the position you desire, (see Picture B-P27).

CAUTION: When vehicle is in motion it is recommended that the TV be "OFF" and in the stored position.

To store the flat screen display, swing the screen on its base against the cabinet securing the TV to the latch on the cabinet, (see Picture B-P28).



Picture B-P25: Lifting stove top cover.



Picture B-P26: Counter top with sink cover in place.



Picture B-P27: Flat screen display.



Picture B-P28: Flat screen display locking latch.

EXTERIOR ACCESS DOORS:

DRIVER SIDE ACCESS DOORS:

Behind the lockable middle access door, (see Pictures B-P29 and B-P30) the following are found:

1. Macerator manual crank handle.
2. Grey water gate valve handle.
3. Black water gate valve handle.
4. Storage compartment.
5. Sewage hose.

Behind the driver side lockable rear access door, (see Picture B-P32) the following are found::

1. City water connection, (integrated at the left hand side behind the rear access door).
2. Exterior shower faucet
3. Cable TV connection.
4. Shore power cord.

Warning: Before driving ensure the shore power cord and city water line are disconnected and are stored properly.

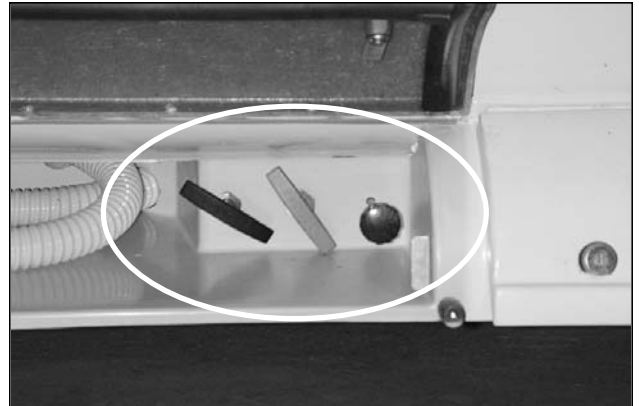

Picture B-P29: Black water, grey water valves and macerator manual crank locations.

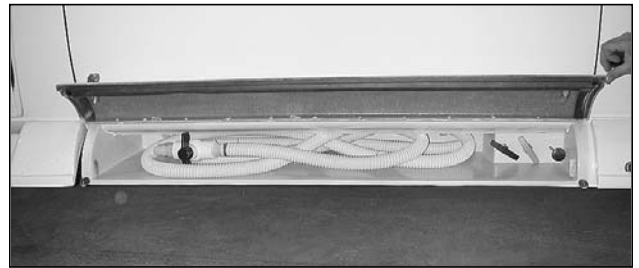

Picture B-P30: Sewage hose storage location.



Picture B-P31: Location of the exterior fresh water tank drain valve (open position).

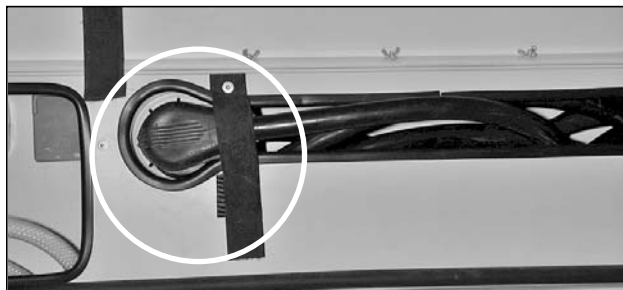

Picture B-P33: Location of exterior shore power cord, (stored position).



Picture B-P32: Location of the city water supply connection.

PROPANE ACCESS DOOR:

Behind the drivers side middle **propane access door**, (see Picture B-P34), the following are found:

1. Propane fill valve.
2. Propane tank shut off valve.

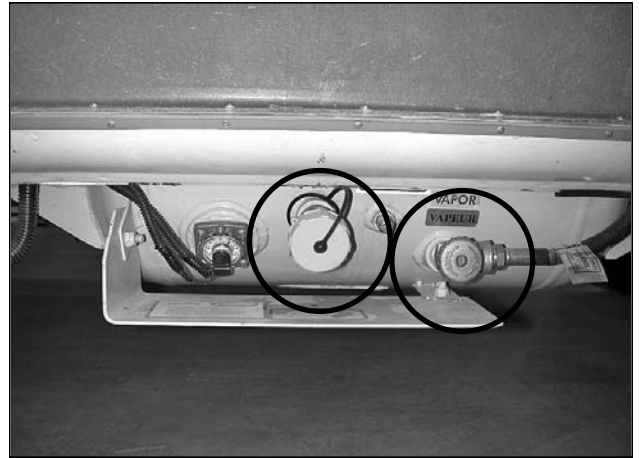

Picture B-P34: Propane tank/fill access door.

REAR STORAGE AREA:

In the rear storage area the following are found:

1. Auxillary battery(s).
2. Rear storage light switch.

Auxillary battery(s) are stored in the rear storage area on the passenger side under the floor, (see Picture B-P35).



Picture B-P35: Auxillary battery storage area, (dual battery option shown).

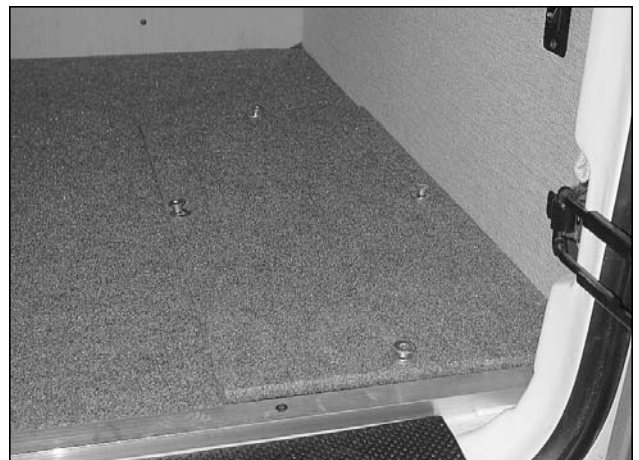

Picture B-P35A: Battery storage lid.

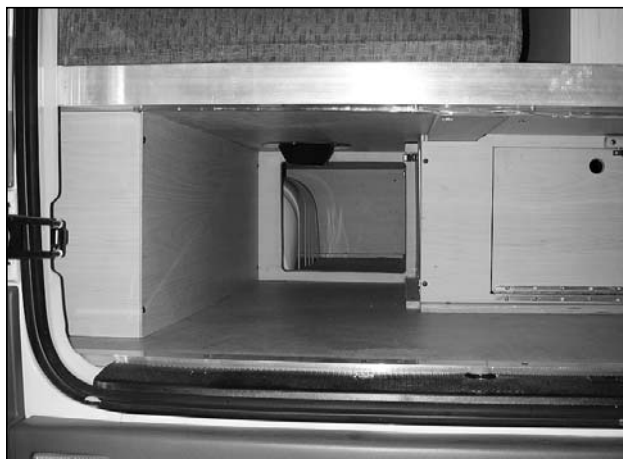

Picture B-P36: Rear storage area (drivers side).



Picture B-P36A: Rear storage light switch (passenger side).

AUXILIARY BATTERY:

The auxiliary battery(s) are located under the passenger side bench in the rear storage area below the floor, (see Picture BP37).

It is recommended to check the battery/ies condition once a month, (see maintenance section).

In order to access the auxiliary battery one must do the following:

1. Remove the battery cover retaining screws, (see picture B-P37)
2. Remove battery access compartment cover.

To reinstall reverse steps 1 and 2 above.

CAUTION: BATTERY ACID CAN BURN YOUR SKIN AND DAMAGE YOUR CLOTHING. PROTECTIVE EYE WEAR AND GLOVES SHOULD BE WORN WHEN HANDLING.

Observe all battery warnings and caution labels.

NOTE: Your vehicle is equipped with a group 27 lead acid auxiliary battery. It is recommended that acid levels be checked at least once every month. See battery manufacturers maintenance recommendations.

If your vehicle is equipped with the dual battery option, your batteries are two 6V lead acid. See battery manufacturers maintenance recommendations.

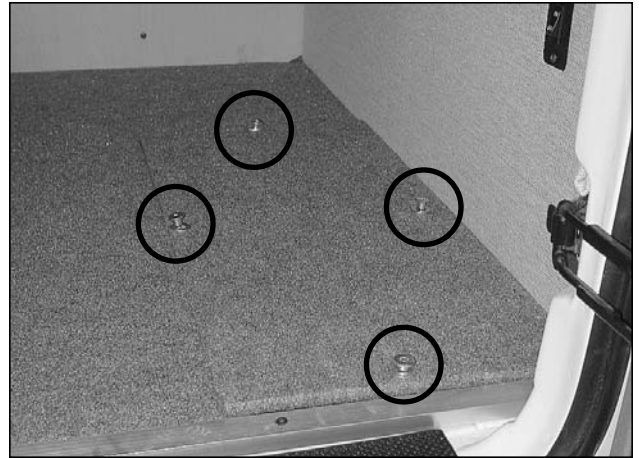

Picture B-P37: Auxiliary battery compartment cover retaining screws.



Picture B-P38: Dual battery option shown.

REPLACING THE AUXILIARY BATTERY:

Replacement battery must be a group 27 deep cycle lead acid or equivalent.

Dual battery option if so equipped uses two 6 Volt deep cycle batteries.

Ensure that the battery cable hex nuts are tightened to 10 ft-lbs, (see Picture B-P38).

Ensure that the inverter is disconnected prior to disconnecting the auxiliary battery.

SPARE TIRE STORAGE:

The spare tire is located in the storage area found under the floor behind the rear bumper, (see Picture B-P39A).

Interior storage light switch, (see Picture B-P39).



Picture B-P39: Location of light switch.



Picture B-P39A: Storage area for spare tire.

Mineraling:

Due to the properties of natural Maple wood, Home & Park makes no warranty against the mineraling of wood components, (see Picture B-P40).

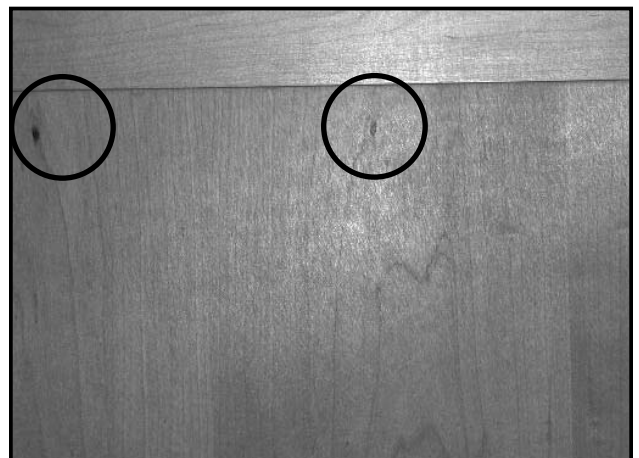

Picture B-P40: Maple cabinet showing mineraling.

SIGNAL SELECTION SWITCH:

Standard A/B Switch:

- A: Antenna.
- B: Cable.

AUDIO/VIDEO CABINET:

The following are found in the audio/video cabinet, (see Picture BP42).

1. A/B signal selection switch.
2. Antenna ON/OFF switch, (Wineguard crank up).
3. Optional DVD player.
4. Audio/Video 110V AC receptacle.

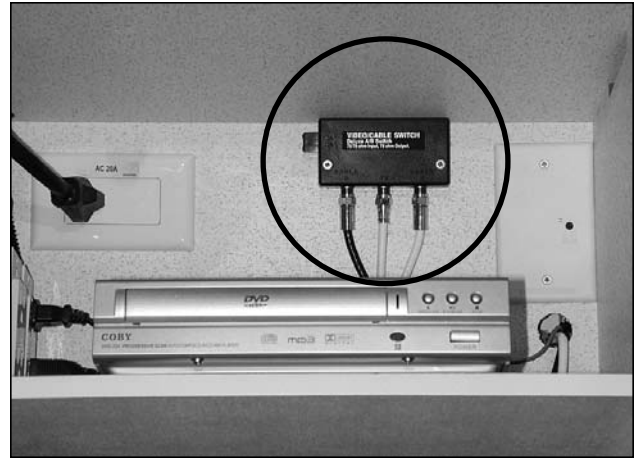

Picture B-P41: Signal selection switch, (standard).

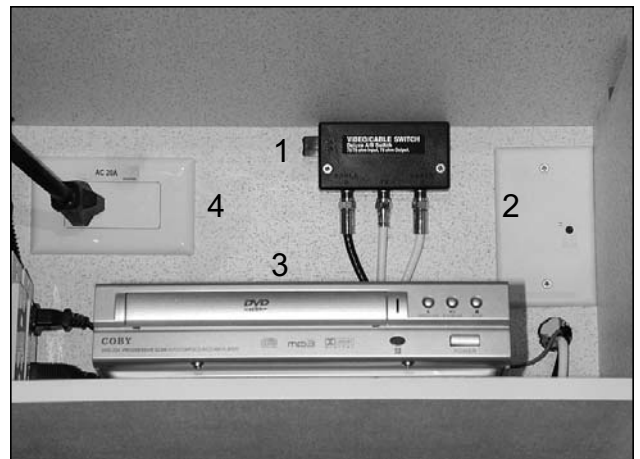

Picture B-P42: A/V cabinet.

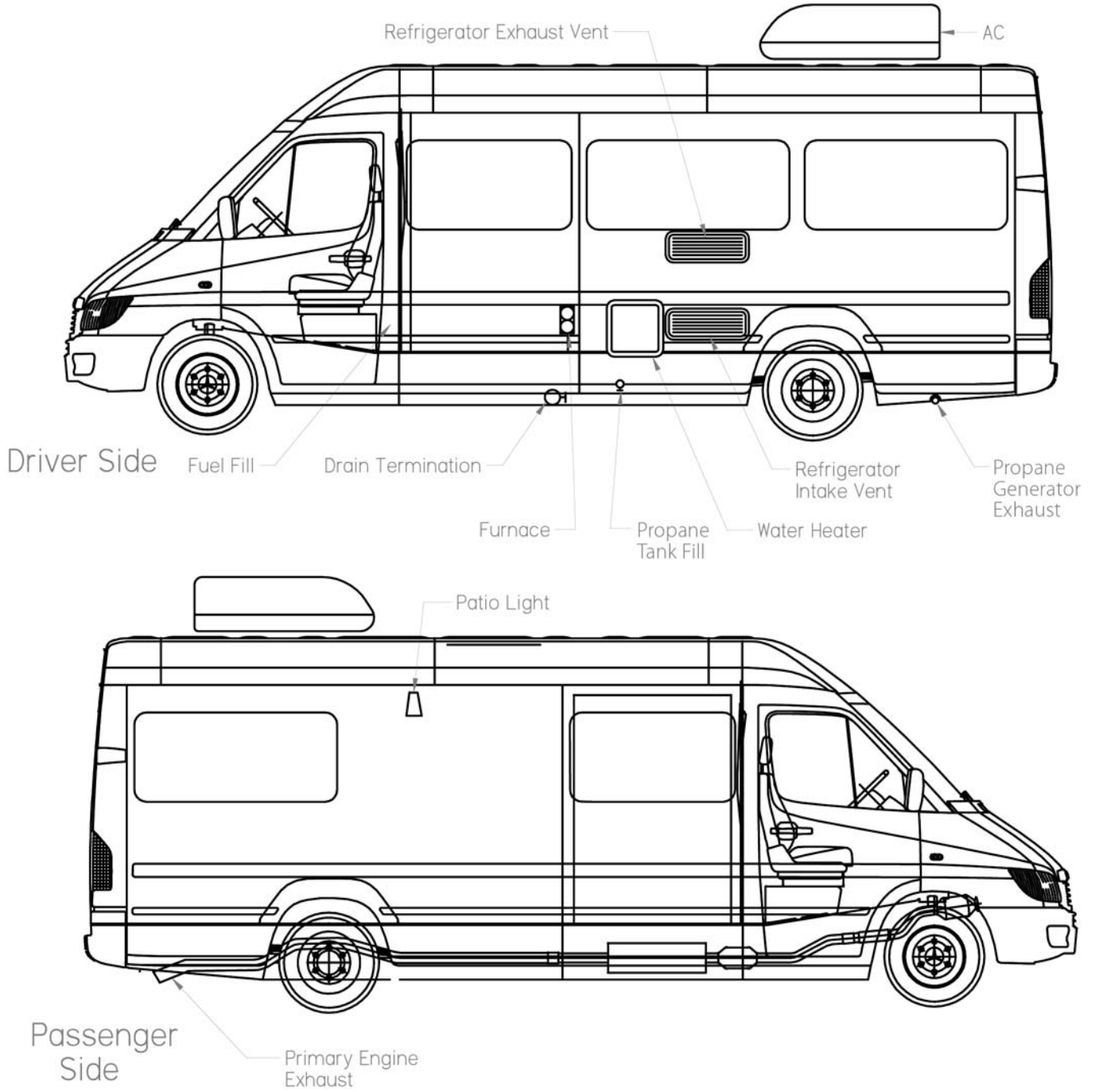

- INTERIOR FINISH MATERIALS HAVE A FLAME SPREAD RATING OF LESS THAN 200
- INTERIOR TEXTILE MATERIALS COMPLY WITH FMVSS 302
- INTERIOR DOORS/PARTITIONS ARE NON-LOCKING

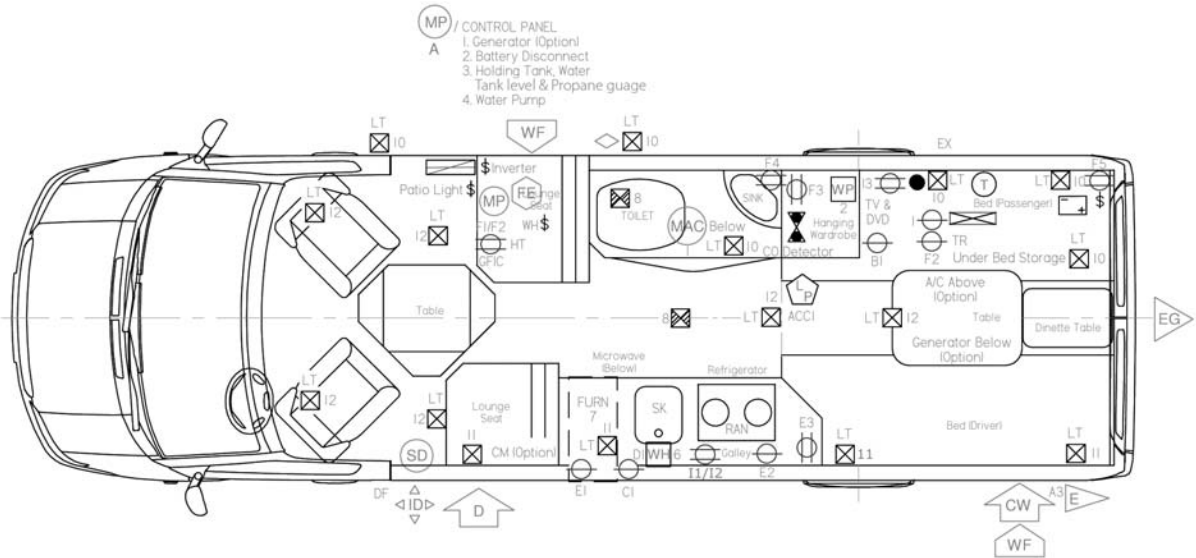

12	12	15	14AWG STANDARD CU	Roof lights, Cab Lights
11	12	15	14AWG STANDARD CU	Driver side lights
10	12	10	14AWG STANDARD CU	Passanger side lights, Patio light, Under bed light
9	12	15	14AWG STANDARD CU	Audio / Video Cabinet / Optional Antenna AMP
8	12	10	16AWG STANDARD CU	Roof vent & Bathroom exhaust fan
7	12	10	14AWG STANDARD CU	Furnace
6	12	10	14AWG STANDARD CU	Water Heater
5	12	20	10AWG STANDARD CU	Refrigerator
4	12	1	18AWG STANDARD CU	CO Detector
3	12	1	18AWG STANDARD CU	Propane Gas Detector
2	12	10	14AWG STANDARD CU	Water Pump
1	12	20	10AWG STANDARD CU	Macerator
I	110	6	14AWG 2CU W/GROUND	Inverter output
II / I2	110	15	14AWG 2CU W/GROUND	Galley Receptacle, (GFCI)
I3	110	15	14AWG 2CU W/GROUND	Audio / Video (AV), cabinet Receptacle
F5	110	15	14AWG 2CU W/GROUND	Rear Passenger Side Receptacle
F4	110	15	14AWG 2CU W/GROUND	Closet Receptacle
F3	110	15	14AWG 2CU W/GROUND	Receptacle - Under Hanging Wardrobe pass side
F2	110	15	14AWG 2CU W/GROUND	Inverter / Charger Receptacle
F1	110	15	14AWG 2CU W/GROUND	Passenger side Lounge Seat Receptacle, (GFCI)
E3	110	15	14AWG 2CU W/GROUND	Rear side Galley Receptacle
E2	110	15	14AWG 2CU W/GROUND	Fridge Receptacle
E1	110	15	14AWG 2CU W/GROUND	Coffee Maker Receptacle
C1	110	15	14AWG 2CU W/GROUND	Microwave oven Receptacle
B1	110	20	12AWG 2CU W/GROUND	Air conditioner / Heat pump
A2	110	30	10AWG 2CU W/GROUND	Transfer switch Load
A	110	30	10AWG 2CU W/GROUND	Main Power Switch
Circuit	VOLTS	AMPS	WIRE SIZE	LOADING

CIRCUIT SCHEDULE

NOTE: INVERTER/CHARGER

Your Owner's Manual for RV750ULHW contains most of the essential information you need to enjoy the electrical conveniences of home while at RV parks or dry camping. However, we wish to highlight for you exactly how the charging portion of the inverter/charger works, in order to help avoid possible confusion:

Supplying shore power or, (optional) generator power enables RV750ULHW to charge the auxiliary battery(s). Operation of your vehicle engine and alternator will also charge the auxiliary battery(s). When your motorhome is not plugged into shore power or, (optional) AC generator power, all electricity you use draws power from your motorhome's auxiliary battery bank, with the inverter allowing you to enjoy quiet DC-to-AC, (12 volt to 120 volt) power in the absence of shore or generator power.

10V inverter/charger shut down

As a safety feature, the inverter component of the RV750ULHW inverter/charger, (which changes DC battery power to AC electricity) will shut itself down when your auxiliary battery bank drops below 10 volts DC. This occurs in order to avoid excessive discharging and potential damage to the battery(s), as well as to preserve sufficient battery voltage to maintain the functionality and readiness of the battery charger component of the RV750ULHW. It is possible, however, for the battery(s) to become discharged below 10 volts DC as a function of activity other than using the inverter. For example, while dry camping, in the absence of shore or generator power, if a 12 volt appliance such as the furnace or lights are left on for an extended period of time.

Dry camping battery conservation

While dry camping, (no 110 VAC power available) to conserve battery power, it is recommended to switch the inverter/charger to the off or charge position, if the inverter is left in the ON position, it will continue to draw 1.25 amps. To ease in switching the inverter/charger to the off position, you will find the remote ON/OFF inverter/charger switch on your control panel.

Receptacle functionality

When using your motorhome and connected to shore power or optional generator, the receptacles in the audio/video cabinet and in the galley will function to the 15 amp capacity supplied from the distribution panel. However when no shore power or option generator power is available, these receptacles are limited to the 750 watts, (15 amps) output from the inverter/charger.

If an overload occurs, the inverter/charger will shut down, and will need to be reset manually, by turning the inverter off for 1 minute, removing the load, and then turning the inverter/charger back on.

WARNING: Prior to servicing the 110 VAC Galley GFCI or Audio/Video cabinet interior receptacles, the inverter/charger output lead **MUST** be unplugged. These outlets will have live 110 Volt power to them from the inverter/charger even if the shore power is disconnected.

Your vehicle's electrical system should not be subjected to changes and / or additions to circuitry, appliances, etc. without consulting your dealer or Home & Park for proper installation procedures.

Failure to do this could result in serious safety issues or component damage. Changes to the electrical system run the risk of voiding the warranty.

110 / 12V INVERTER / CHARGER / DISTRIBUTION PANEL:

For your convenience when camping in parks with hookups for 110V power, (shore power), all our models have in the electrical system a 110/12 volt distribution panel / inverter / charger. The inverter/charger provides 12 volt power for the 12 volt appliances and the inverter provides 110 volt power for the galley receptacle and the audio/video receptacle. The inverter/charger also charges the auxiliary battery(s) present in the system.

See "Floor Plan & Appliance Location" for the distribution/inverter/charger location. To open the distribution panel simply pull on the access door until the cover is released. All of the 110 volt circuit breakers and 12 volt fused circuits are identified inside the distribution panel, (behind the distribution panel access door).

EXTERNAL ELECTRICAL SOURCE CONNECTION:

Your vehicle is equipped with a heavy duty 30 amp. shore power cord so that you can connect your electrical system to an outside 110V, (30 amp) power source.

The power cord is stored in the storage compartment, (see picture G-P19) located behind the driver side rear tire.

NOTICE: Do not place heavy or sharp objects on the power cord.

A 30 to 15 amp. adapter is **not** included with your vehicle.

NOTICE: When connecting your system to an external power source, ensure that a properly equipped, (three pronged) and functioning receptacle is used. If any type of spark or shock is detected, disconnect from the source immediately and do not reconnect until the problem is corrected.

GENERATOR:

All service requirements are listed in the Onan Owner's Manual.

The generator is located and accessed from the underside of the van behind the rear axle of your vehicle.

CAUTION: When launching a boat, (using your Roadtrek), it is important to note that the generator must not be submerged in water. This will permanently damage the generator. If you cannot launch without submerging the generator, an alternate method would be to use a boat launching service.

Notice: The propane generator on the Sprinter units runs on propane from the same propane tank as the appliances.

MONITOR PANEL:

The monitor panel is located on the shelf above the passenger lounge seat, (see Picture E-P1). For location of the porch lights switch with the optional armoire, (see Picture E-P2).

The monitor panel is used to provide the approximate fluid levels in the fresh, grey and black, (holding) water tanks, the propane tank, and the charge level of the auxiliary battery(s).

The monitor panel has a series of L.E.D. lights, that mark the fluid levels at set increments of F, (full), 2/3, 1/3 and E, (empty). Therefore with respect to the water tank levels, you must be aware that the panel does not always reflect the actual fluid levels. For example, when the 1/3 level light is on, the tank may be anywhere from 1/3 to just under 2/3 full. When the panel reads empty, the tank may be anywhere from empty to just under 1/3 full.

The black and grey water tanks must be flushed regularly with sanitation fluid, to prevent the accumulation of solids on the probes, to maintain accurate black and grey water level readings. Required tank flushing will vary depending on the amount of usage.

To flush out the holding tanks: Refer to the instructions on the Waste Tank Dumping found in the Water Systems Section.

The auxiliary battery charge level indicator is marked "C," "G," "F," and "L."

1. "C" indicates the battery is fully charged and/or charging.
2. "G" indicates the battery charge is "good".
3. "F" indicates "fair".
4. "L" indicates "low".

The battery condition is indicated by the uppermost light that is on. For example, if the "G," "F," and "L" lights are on, the battery charge is "good".

The panel also provides the switch for the water pump and a disconnect switch for the auxiliary battery(s).

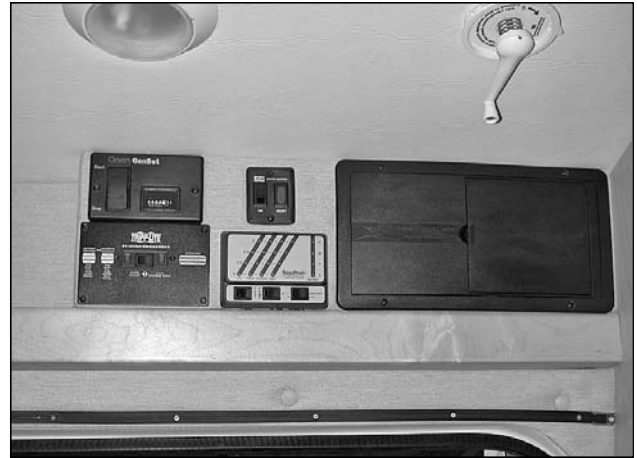

Picture E-P1: Monitor panel, water heater switch, 110V/12V distribution panel and optional generator control switch.



Picture E-P2: Location of the porch light switch.



Picture E-P3: Location of the crank up antenna handle.

AUXILIARY BATTERY(S) AND BATTERY SEPARATOR:

The auxiliary battery is a group 27 lead acid battery. The auxiliary battery is located in the rear storage area under the bed on the passenger side, (see section on Auxiliary Battery). To access the battery refer to the auxiliary battery section found in the Daily Living section.

The auxiliary battery is automatically charged through the battery separator by the engine's alternator while the engine is running. This battery is also automatically charged by the inverter / charger when:

1. The battery disconnect switch on the monitor panel is set to the "ON" position prior to connection to an outside electrical power source, (shore/generator power).
2. The breakers in the distribution panel, are in the "ON" position.
3. Or while the generator is in operation, (if so equipped).

A disconnect switch, located on the monitor panel, provides a disconnect for the auxiliary battery from the 12V system while your vehicle is not in use.

Since the auxiliary battery(s) are of a deep-cycle type, it may be discharged completely and recharged without damage, (whereas the automotive battery is designed to be kept fully charged by the alternator and may undergo damage if fully discharged). However, **the auxiliary battery should never remain in a discharged state and should be recharged immediately to prevent battery damage.** When not in use, the auxiliary battery will slowly discharge on its own.

Accordingly, if the battery is not being used, it should be recharged monthly by connecting to an outside electrical power source, by operating the generator, (if equipped) for at least 12 hours, or by running your vehicle's engine for a minimum of 2 hours.

The **battery separator** is located under the hood in the engine compartment. The battery separator allows the alternator to charge both the automotive and auxiliary batteries when the engine is running, and it will prevent your vehicle's 12V motorhome equipment, (interior lights, water pump, exhaust fans, furnace blower, etc.) from drawing on the automotive battery.

AUTOMOTIVE BATTERY:

The automotive radio in your vehicle will exert a small draw on the automotive battery to maintain the time and preset stations.

To prevent the battery from being completely discharged, the radio should be disconnected from the automotive battery when your vehicle will be out of service for 2 months or more. Failure to do this may risk voiding the warranty on the automotive battery.

The radio can be disconnected by removing the 10 amp. radio fuse from the automotive fuse block, located on the steering column under the steering wheel, or by disconnecting the negative automotive battery cable. See Automotive Owners Manual for full radio operating instructions.

INTERIOR CAB LIGHT :

The interior 12V cab light located on the underside of the cab ceiling panel has a multipurpose switching system. This switching system utilizes the switch on the light itself.

Refer to the Dodge Sprinter's Owner's Manual for complete operation instructions.

WATER HEATER :

The Roadtrek is equipped with a propane fueled water heater. The water heater must be operated by propane. Please refer to the Suburban Owner's Manual for complete operation instructions.

REAR STORAGE LIGHT :

The inside rear storage light is powered by the auxiliary battery. The switch is located on the passenger side rear door post, (see Picture B-P36A).

	POTABLE WATER FILL		T.V. JACKS	SK	KITCHEN SINK
	CITY WATER INLET		THERMOSTAT	TR	TRANSFER SWITCH
	POTABLE WATER PUMP		MONITOR PANEL	WC	WATER CLOSET
	DRAIN OUTLET		MACERATOR	WH	WATER HEATER
	INSIGNIA LOCATION		BATTERY STORAGE	WT	WATER TANK
	FIRE EXTINGUISHER (MIN. 10B.C.)		PROPANE DETECTOR		
	EMERGENCY EGRESS (17"x24" min.)	A/C	AIR CONDITIONER		
	MFG. ID LABEL	BAT	BATTERY CHARGE LEVEL INDICATOR		
	SMOKE DETECTOR	CM	COFFEE MAKER		
	CARBON MONOXIDE DETECTOR	EX	ENGINE EXHAUST		
	INVERTER / CHARGER	FURN	COMFORT HEATING APPL.		
	110V DISTRIBUTION PANEL	GEN	GENERATOR SET		
	12V FUSE BLOCK / BOX	GF	GASOLINE FILL		
	110V + 12V DISTRIBUTION PANELS	GFI	GROUND FAULT INTERRUPT		
	110V SINGLE RECEPTACLE	GFIC	GROUND FAULT INTERRUPT CIRCUIT		
	110V DUPLEX RECEPTACLE	HT	HOLDING TANK		
	110V SPLIT DUPLEX RECEPTACLE	LAV	LAVATORY		
	SINGLE POLE SWITCH	PROPANE	PROPANE STORAGE TANKS		
	2 POLE DBL THROW SWITCH	MIC	MICROWAVE		
	12V LIGHT FIXTURE	RAN	COOKING APPLIANCE		
	12V EXHAUST FAN	REF	REFRIGERATOR		
	COMB. 12V FAN/LIGHT FIXTURE	RH	RANGE HOOD		
	120V ELECTRICAL INLET	SHW	SHOWER		

LEGEND

ROADTREK MOTORHOMES
SYMBOLS AND ABBREVIATIONS LEGEND

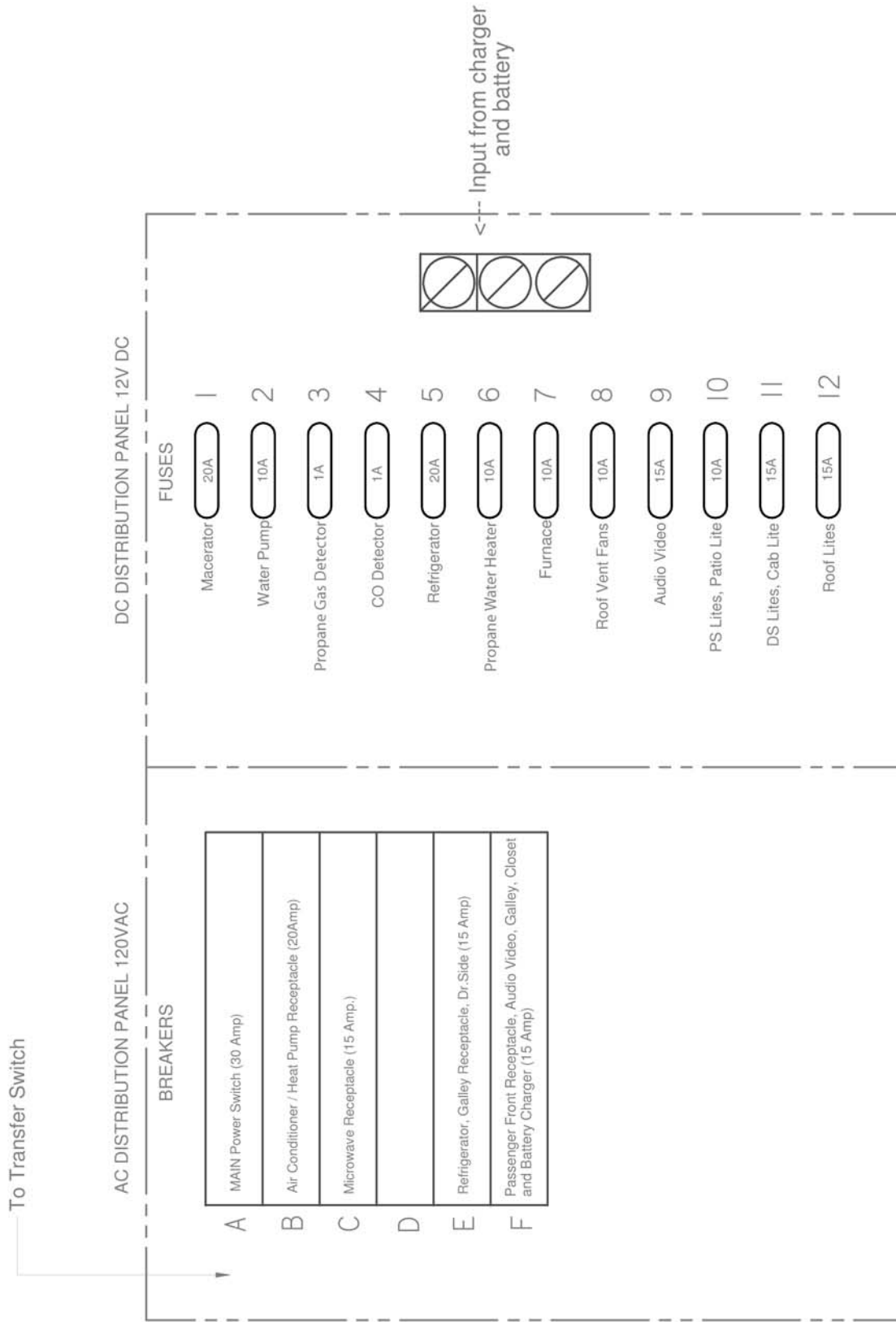

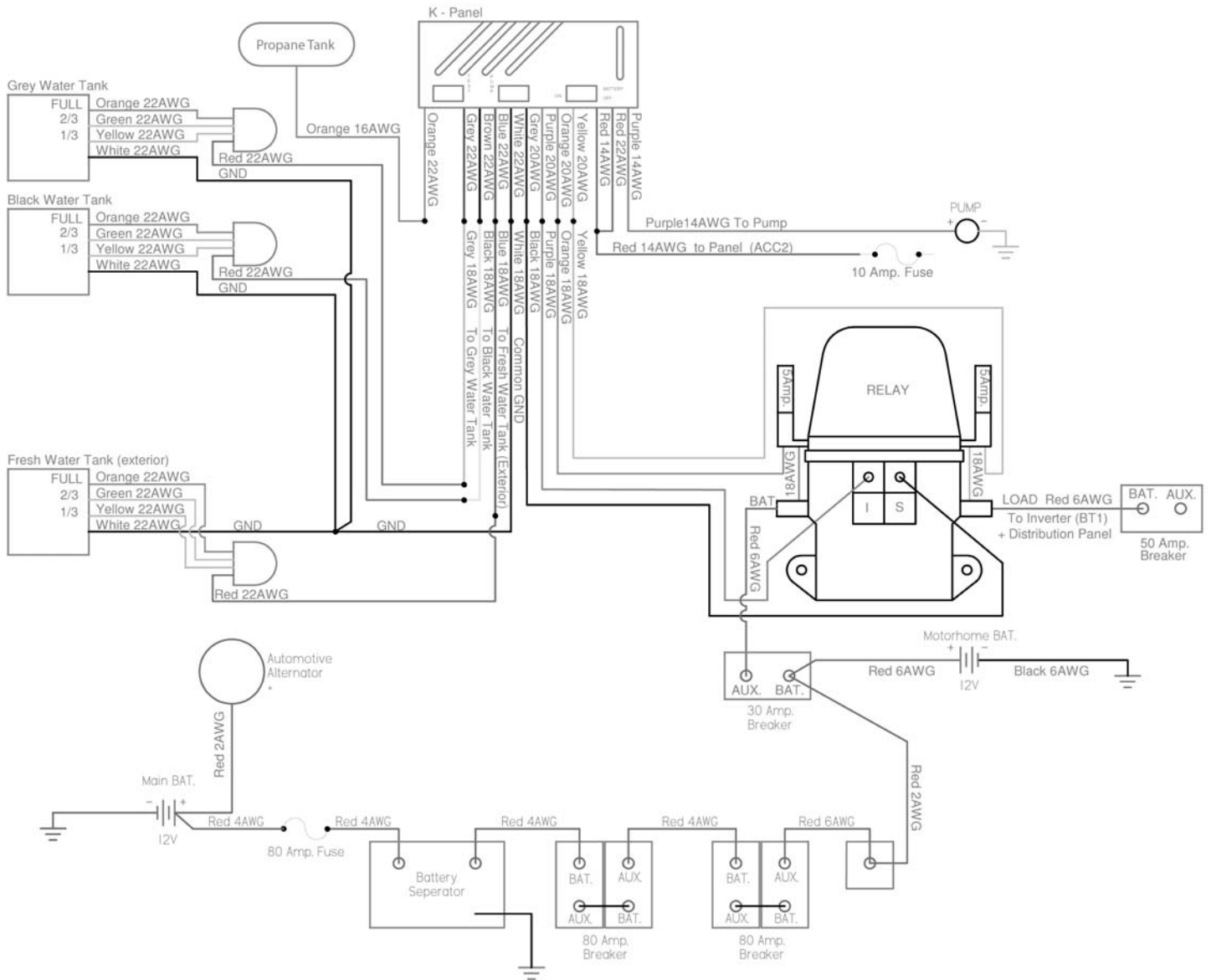

Your vehicle is equipped with a propane system which, when properly handled and maintained, will provide trouble and worry free operation of your propane fueled appliances.

Propane fuel is stored in a liquid state under extremely high pressure. As fuel is used, propane gas passes from the top of the tank through the regulator into the propane gas lines and eventually to all of the propane fueled appliances.

Although the entire system has undergone extensive factory and dealer testing for leaks, the system's connections and fittings are subjected to road vibrations and therefore **should be checked annually for possible leaks by a licensed propane installer.**

Propane fuel is extremely flammable, colourless, heavier than air and smells like garlic or rotten eggs.

IF YOU SMELL PROPANE GAS, extinguish any open flames, pilot lights and smoking materials **immediately**. Do not touch any electrical switches. Leave vehicle, shut off the gas supply at the tank valve and open doors and windows to provide maximum ventilation. Leave the area until the odor clears. Have the system checked and the leak corrected before further use.

The propane fuel tank valve must be open to operate gas fueled appliances.

WARNING: Propane tanks shall not be placed or stored inside your vehicle. Propane tanks are equipped with safety devices which relieve excessive pressure by discharging gas to the atmosphere.

WARNING: To reduce the danger of fire or explosion do not store gasoline or other flammable liquids inside your vehicle.

WARNING: Ensure you purchase propane from a reputable propane facility. Contaminated propane is a common cause of system failure.

WARNING: Follow all recommended maintenance schedules.

PROPANE TANK:

To open and close the propane tank, use the manual propane tank shutoff valve located on the propane tank, accessible from the driver side access door.

It is recommended to close the propane tank shutoff valve when the vehicle is not in daily use. Further, it is recommended to close the propane shutoff valve while the vehicle is in travel.

The refrigerator should only be operated on 12 volt when the vehicle is in travel. See refrigerator Manufacturers Owner Manual for proper 12 volt operation.

APPLIANCES:

WARNING: It is not safe to use cooking appliances for space heating purposes due to the danger of asphyxiation.

WARNING: The propane stove needs fresh air for its safe operation.

Because the amount of air supply is limited by the size of your vehicle, before operating the propane stove, open the overhead vent or a window for increased air circulation, (see Floor Plan & Appliance Location). Proper ventilation when using the propane stove will reduce the dangers of asphyxiation.

WARNING: Portable fuel burning equipment, including wood and charcoal grills and stoves, should not be used inside your vehicle. Use of this equipment inside your vehicle, may cause fire or asphyxiation.

See appropriate component Manufacturer's Owner's Manuals for operating instructions.

REFUELING PROCEDURES:

WARNING: Do not refuel the propane tank to more than 80% of its capacity.

A properly refueled propane tank will hold approximately 80% of its volume in a liquid state. Over fueling of the propane tank can result in uncontrolled gas flow which can cause a fire or explosion.

WARNING: The propane tank valve must be closed and **ALL PILOT LIGHTS, APPLIANCES, AND THEIR IGNITERS, (see Operating Instructions) SHALL BE TURNED OFF** during refueling of motor fuel tank and / or the propane tank. Only qualified personnel should refuel your propane tank.

REGULATOR:

The propane regulator is located adjacent to the propane tank.

This regulator has been installed under a protective cover to keep out debris, with the vent facing downward.

PROPANE LEAK DETECTOR:

Your vehicle has been equipped with a propane leak detection device for your protection, (see Picture F-P1).

See "Floor Plan & Appliance Location" for location of the propane leak detector.

Be sure that the propane leak detector is operating while using your vehicle.

Do not block air circulation in the area where the propane leak detector is located.

See Manufacturer's Owner's Manual for other operating instructions.

WARNING: Battery disconnect switch must be in the "ON" position for the propane leak detector to operate



Picture F-P1: Propane leak detector.

CARBON MONOXIDE LEAK DETECTOR:

Your vehicle is equipped with a carbon monoxide, (CO) detection device for your protection, (see Picture F-P2).

See "Floor Plan & Appliance Location" for location of the carbon monoxide gas detector.

Be sure the carbon monoxide gas detector is operating while using your vehicle.

Do not block air circulation in the area where the carbon monoxide gas detector is located.

See Manufacturer's Owner's Manual for other operating instructions.

WARNING: Battery disconnect switch must be in the "ON" position for the carbon monoxide gas detector to operate.

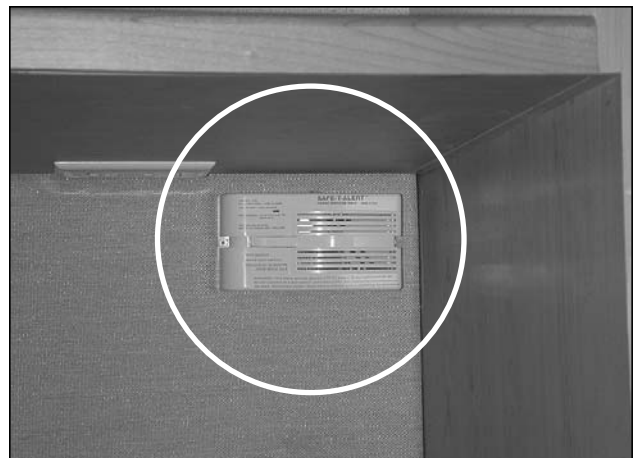

Picture F-P2: Carbon monoxide gas detector.

SMOKE DETECTOR:

Your vehicle is equipped with a smoke detection device for your protection, (see Picture F-P3).

See "Floor Plan & Appliance Location" for the smoke detector location.

This device should be tested after each time your vehicle has been in storage, before each use, and at least once each week during your vehicle's use.

NOTE: Upon delivery of your vehicle from the factory, the smoke detector is inoperative due to the fact that the battery has been reversed to prevent battery drainage. Before operation, reverse the battery to the proper position and test the operation of the smoke detector by pressing the test button located on the front of the smoke detector.

Be sure the smoke detector is operating while using your vehicle. Do not block air circulation in the area where the smoke detector is located.

See Manufacturer's Owner's Manual for operating instructions.

NOTE: Cleaning products, sealants, and some adhesives may contaminate safety detectors. All of the detectors should be covered when using cleaning chemicals or working on the vehicles interior.



Picture F-P3: Smoke detector.

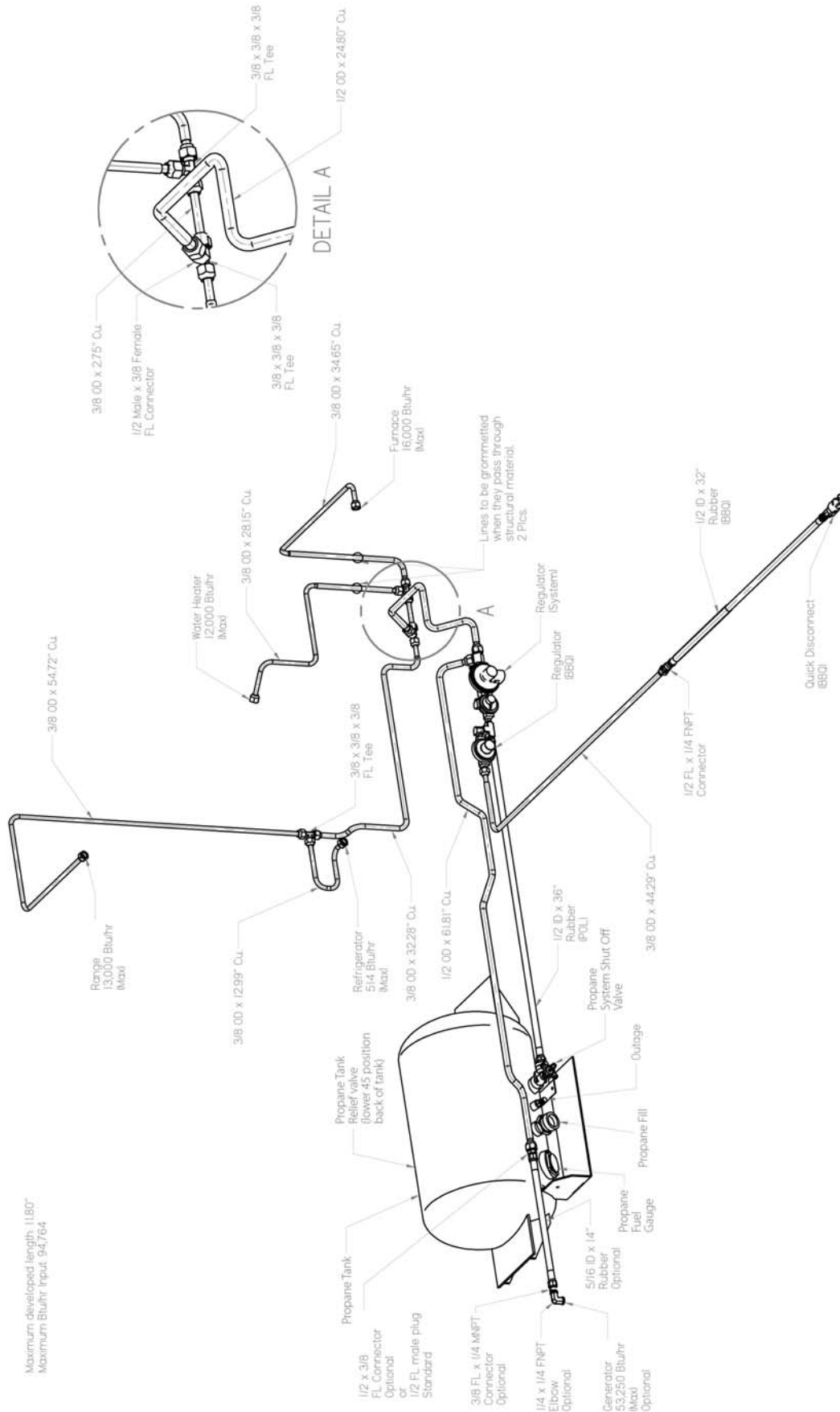

WATER HEATER BYPASS SYSTEM:

Your Roadtrek is equipped with a water heater by-pass valve. When it is in summer mode, all three valves will face the aisle, (see Picture G-P1). In winter mode, the water line valve in the middle of the water line should be in the open position, (inline with the water line) and the valves at the water heaters cold water inlet and the hot water outlet should be in the closed position, (see Picture G-P2).

FRESH WATER TANK DRAIN:

To drain the fresh water tank you must open exterior fresh water drain valve at the low point fresh water tank drain, located behind the passenger side front tire, (see Picture G-P3).

TO DE-WINTERIZE:

Repeat the steps in reverse order.

NOTE: By using antifreeze in the black and grey waste water tanks, the waste water system can be used in moderate subfreezing conditions.

Home & Park Motorhomes makes no warranty what so ever for damage to the water systems as a result of freezing.

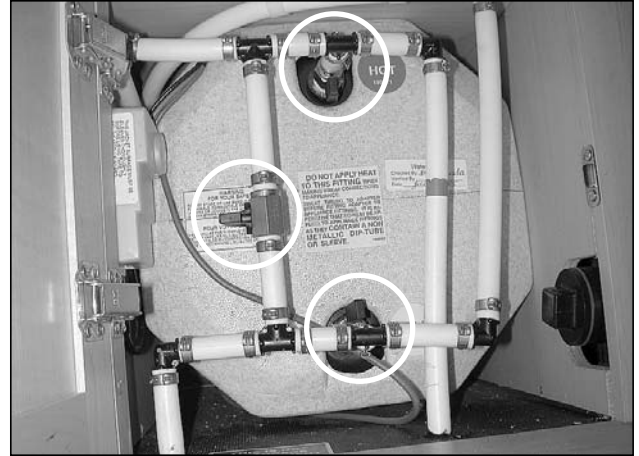

Picture G-P1: Water heater by-pass valve positions, (summer mode).



Picture G-P2: Water heater by-pass valve positions, (winter mode).



Picture G-P3: Location of the exterior freshwater tank low point drain.

FRESH WATER TANKS:

Your vehicle is equipped with a water system for either completely self contained or fully dependent use. It is **NOT** equipped with a pressure regulator to compensate for varying water pressure levels.

During self contained use, caution should be taken so as to minimize water consumption. For example, water consumption can be reduced while showering if you turn off the shower between wetting down and rinsing off.

To avoid damage due to road vibrations, be sure not to store heavy or sharp objects where they may come into contact with either the water lines or water pump. Also, allow sufficient room around the water pump for proper operation.

FILLING THE FRESH WATER TANK:

1. Open the passenger side entry door.
2. Open the gravity fill cover, (see Picture G-P4).
3. Insert the hose and fill the fresh water tank using moderate water pressure, (excessive pressure will result in a back flow of water).
4. When the tank is full, water will overflow back through the gravity fill hole.
5. Overfilled tanks will spill out through the fresh water tank fill vent.



Picture G-P4: The gravity fresh water fill for the fresh water tank, (located on the passenger side lounge seat).

The fresh water tank can also be filled through the city water inlet located behind the rear lockable driver side access door, (see Picture G-P5). The use of the city fill is not possible when the fresh water system has been winterized.

To fill the fresh water tank:

1. Prior to using city fill, ensure that the fresh water system is in summer use mode, and has been de-winterized and the fresh water system has been sanitized, (see Picture G-P1 on page G-1). Connect a hose to the city water inlet connection. Remove the orange gravity fill plug for added venting of the fresh water tank, (see Picture G-P4).
2. To fill the fresh water tank, open the city fresh water tank fill shut off valve, (see Picture G-P6).
3. Open the water source moderately.
4. When the tank is full, water will overflow in the same manner as when using the gravity fill, (see previous page).
5. Close the city fresh water tank fill shut off valve, (see Picture G-P7).

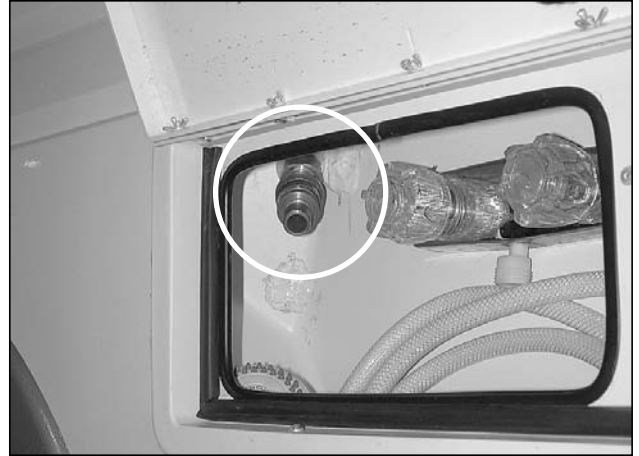

Picture G-P5: Location of the city fresh water inlet connection.



Picture G-P6: Open position of the city fresh water tank fill valve.



Picture G-P7: Closed position of the city fresh water tank fill valve.

CITY WATER CONNECTION:

NOTE: City water connection can only be used in summer operation mode.

The city fresh water inlet connection is located in the small compartment behind the driver side rear access door, (see Picture G-P5). To connect the water system to an outside source:

1. Ensure that the water pump is turned off.
2. Close the city fresh water tank fill valve by turning the handle to the vertical position, (see Picture G-P7).
3. Be sure that all interior faucet's are closed to prevent spillage.
4. Open the city water source slowly to prevent excessive water force inside your vehicle. To protect your system from excessive pressure from water supply systems encountered in some areas, a water pressure regulator should be used. Such a regulator is not supplied with your vehicle.
5. Note that this connection by-passes the water pump and fresh water tank. Therefore, the use of these items is not necessary when connected directly to an external water source.

To disconnect the city fresh water connection:

1. Turn off the external fresh water source.
2. Open the sink faucet to relieve the pressure in the system, (failure to do so may result in an unexpected shower).
3. Ensure that the city fresh water tank fill valve is closed, (see Picture G-P7).
4. Remove the hose from the city fresh water connection, replace the cap on the city fresh water fill connection.

WASTE WATER STORAGE AND DUMPING SYSTEM:

Your vehicle is equipped with a waste water storage and dumping system that will provide adequate and effective storage and dumping of waste water. Your vehicle should be as level as possible to allow optimal operation of the system.

CAUTION: Ensure that both the black and the grey water gate valves are closed, (inward position) before using the waste water system. This applies especially after extensive driving. Black and grey water dump valves are accessed behind the long driver side storage door, (see Picture G-P8 and G-P9).

Waste Water Tank Preparation:

Your vehicle is equipped with two waste water tanks; the grey waste water tank is for waste water from the sink and shower. The black waste water tank is for sewage from the toilet. Both tanks are equipped with separate dump valves so that each may be dumped independently. Before use of either waste tank, be sure to read instructions provided by the toilet manufacturer regarding the use of waste water chemicals. We suggest that such chemicals be used every time to minimize odours and build up of solids on the water level sensors inside the tanks.

CAUTION: During winter use under moderate subfreezing conditions the use of RV antifreeze is required in the black and grey waste water tanks. Antifreeze should be used at at least a 50-50 ratio of water and antifreeze.

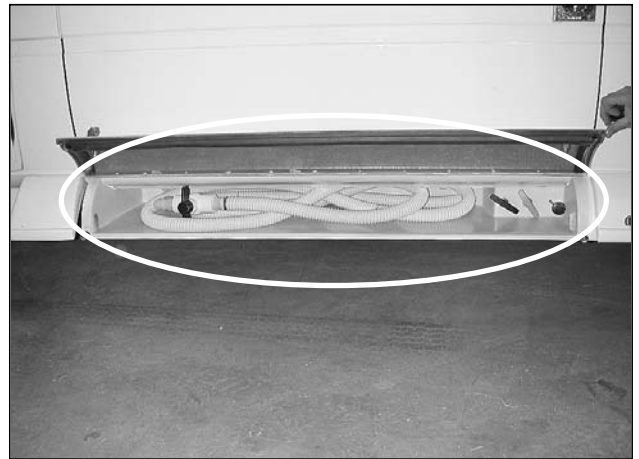

Picture G-P8: Driver side storage door.

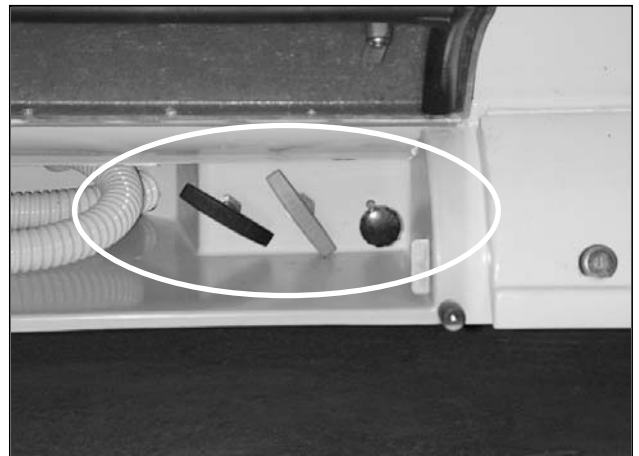

Picture G-P9: Access to the sewer discharge assembly, black and grey gate valve handle and the macerator manual crank handle.

Waste Water Tank Dumping:

To dump the exterior black waste water tank:

1. Turn the battery disconnect switch to the "ON" position, if not already on, (located on the monitor panel).
2. Remove the sewage discharge hose from storage, (see Picture G-P12).
3. Insert the discharge outlet into the waste receptacle.
4. Open the valve on the sewage hose, (see Picture G-P12).
5. Open the black water tank gate valve by pulling the gate valve handle out, (black water tank gate valve has a black handle), (see Picture G-P9).
6. Open the driver's door, press and hold the macerator pump, (red) button until the tank is empty, (see Picture G-P11).

To dump the grey waste water tank:

1. Open the grey water tank gate valve (grey water tank gate valve has a grey handle).
2. Open the driver's door, press and hold the macerator pump, (red) button until the grey waste tank is empty, (see picture G-P11).
3. Close all the gate valve handles by pushing them in to there original position..
4. Close the sewage discharge valve on the end of the sewage hose.
5. Return the sewage hose to its storage compartment.
6. Turn battery disconnect to the "OFF" position.

NOTE: It is recommended to always dump the black water tank first, then the grey water tank to flush out the sewage discharge system.

NOTE: If the macerator should get clogged, you will have to push and turn the manual macerator crank handle to dislodge any debris that might be blocking the macerator, (see picture G-P10).

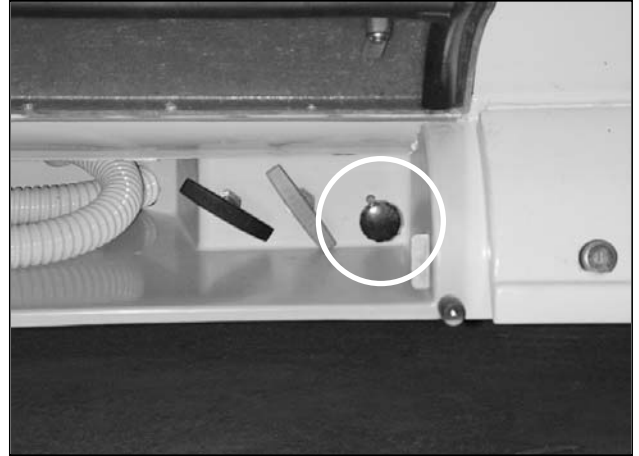

Picture G-P10: Macerator manual crank handle located to the right of the waste holding tanks gate valve handles.

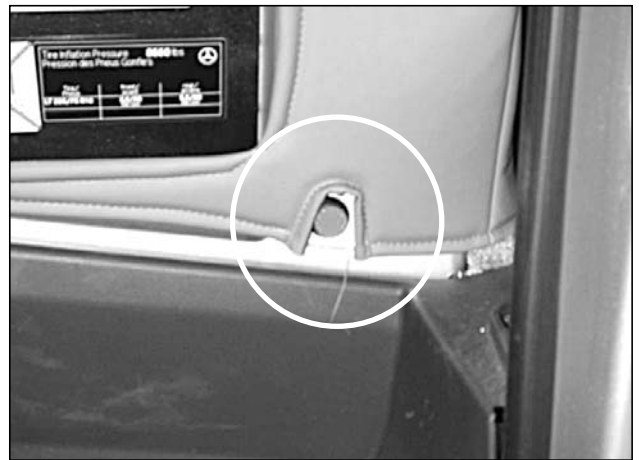

Picture G-P11: Macerator pump switch located at the base of the driver seat pedestal (red button) .

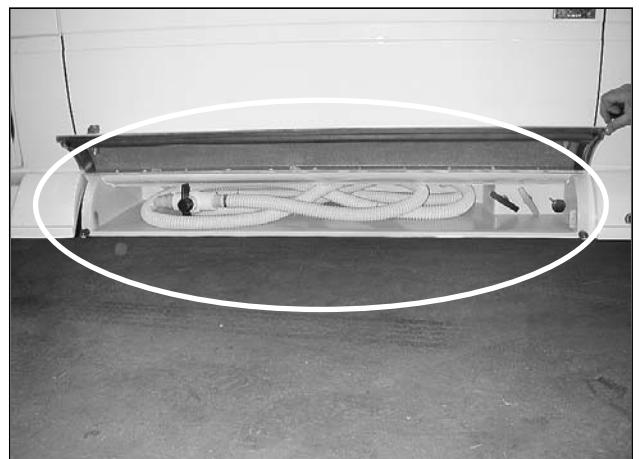

Picture G-P12: Sewage discharge hose storage located in driver's side storage drawer.

Waste Water Tank Flushing:

To flush the waste water tanks:

1. Ensure that both tanks are empty by checking the monitor panel.
2. Fill the black waste water tank by inserting a hose into the toilet, **(be sure to step on the flush pedal, so that the toilet gate valve door stays open to prevent the toilet from overflowing)** and the grey waste water tank using the sink.
3. Dump both tanks using the procedure outlined above on page G-5.

OUTSIDE SHOWER:

NOTE: Outside shower can only be used in summer operation mode.

The outside shower faucet is found in the storage compartment behind the driver side rear wheel. Remove the shower hose from the storage compartment and attach it to the exterior faucet spout, (see Picture G-P13). The shower hose must be returned to the storage compartment before the van is put into motion, as to prevent damage to the unit.

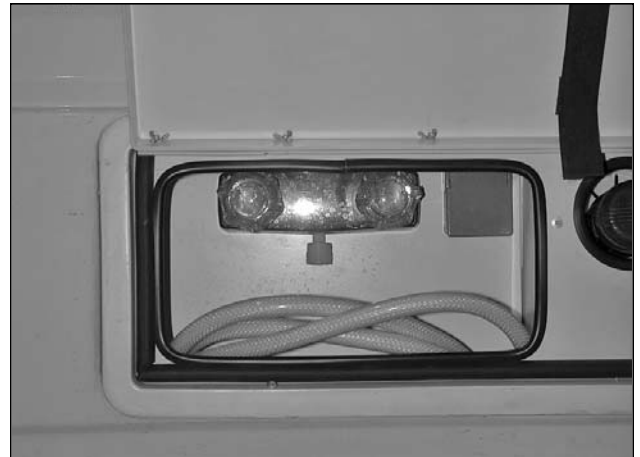

Picture G-P13: Outside shower connection. Shower hose storage when Motorhome is in motion.

POTABLE WATER SYSTEM DRAINING:

NOTE: Water system must be in summer operation mode.

To completely drain the fresh water system of all water:

1. Ensure that the water pump is off and that your vehicle is level.
2. Drain the fresh water tank and the hot and cold fresh water system by opening the exterior fresh water drain valve at the low point drain, on the exterior fresh water tank, (see Picture G-P3 on page G-2).
3. Open all water outlets including the sink faucet, aisle shower faucet, external shower faucet, and toilet flushing pedal. The toilet flushing pedal can be propped open or opened manually several times. This procedure allows gravity to draw any remaining water out through the fresh water tank low point drain.
4. Your vehicle is equipped with a water heater, follow the manufacturer's instructions for draining.
5. Open the sink faucet and turn on the water pump until water is no longer pumped.
6. Turn off the water pump.

If this procedure is followed, it is not necessary to blow out the water system. Once the system is drained, be sure to close all faucets before driving.

NOTE: Do not allow water to sit in the tanks when vehicle is not in use.

POTABLE WATER SYSTEM SANITIZING:

NOTE: Water system must be in summer operation mode.

Your potable water system should be sanitized if it is new, has not been used for a period of time, or may have become contaminated.

To sanitize your fresh water system:

1. Prepare a chlorine solution using 4 L, (1 gallon) of water and 60 ml, (1/4 cup) of household bleach, (5% sodium hypo chlorite solution).
2. With the fresh water tank empty, (see section on Waste Water Tank Flushing), pour, (see section on Filling Fresh Water Tank) 4 L, (1 gallon) of the solution into the fresh water tank for each 60 L, (15 gallons) of the fresh water tanks capacity. As an alternative, several commercial solutions are available and should be used as directed on the package.
3. Complete filling the fresh water tank with fresh water.
4. Turn on the water pump and slowly open all faucet's to release trapped air until a steady stream of water comes out of the faucets.
5. Close all of the faucet's and allow to stand for 3 hours then drain and flush the fresh water system with fresh potable water.
6. To remove excessive chlorine taste or odor which may remain, prepare a solution of 1 L, (1 quart) vinegar to 20 L, (5 gallons) of water and pour into the fresh water tank and allow the solution to agitate in the fresh water tank by vehicle motion, (several days if possible).
7. Drain the fresh water tank and flush with fresh potable water.

WATER SYSTEM WINTERIZING:

NOTE: Water system must be in winter operation mode and the water heater must be in the by-pass mode.

To winterize your potable water system:

1. Drain the entire system including the water heater, (refer to water heater owners manual for instructions on draining).
2. Place water heater by-pass valves in the by-pass position to prevent the water heater from filling with antifreeze.
3. Add 8 L, (2 gallons) of approved nontoxic recreational vehicle antifreeze to the fresh water tank using the fresh water gravity fill.
4. Turn on the water pump.
5. Open all three faucet's, (sink, shower, and the exterior shower) until antifreeze is visible.
6. Open the toilet valve, (by pressing down on the toilet flushing pedal) until antifreeze is visible.
7. Turn off the water pump.
8. Remove the plug for the bathroom shower drain and fill the P-Trap with antifreeze.

To prepare your potable water system for use:

1. Drain the antifreeze from the fresh water system.
2. Sanitize the fresh water system if desired.
3. Fill the fresh water system with potable fresh water.

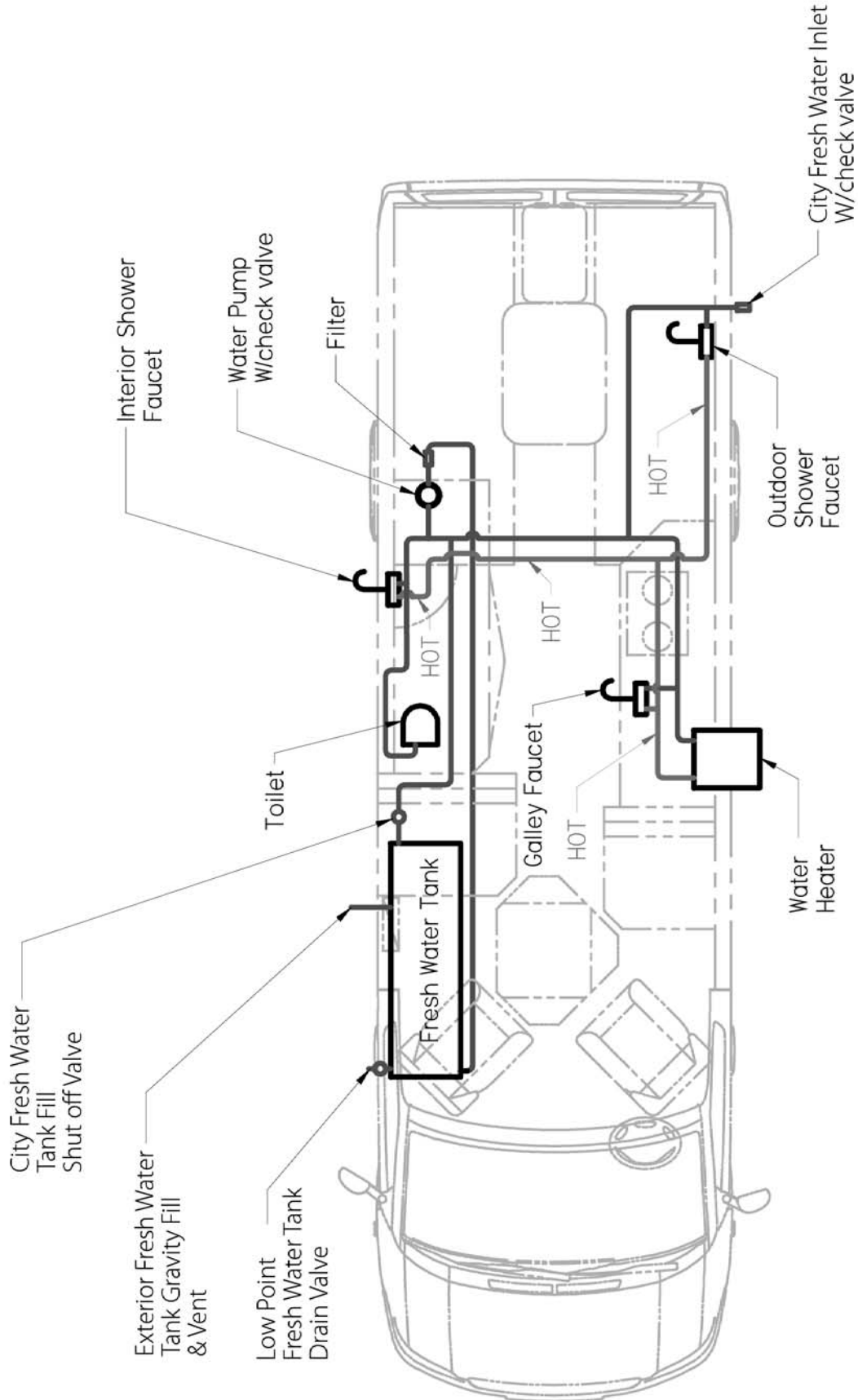

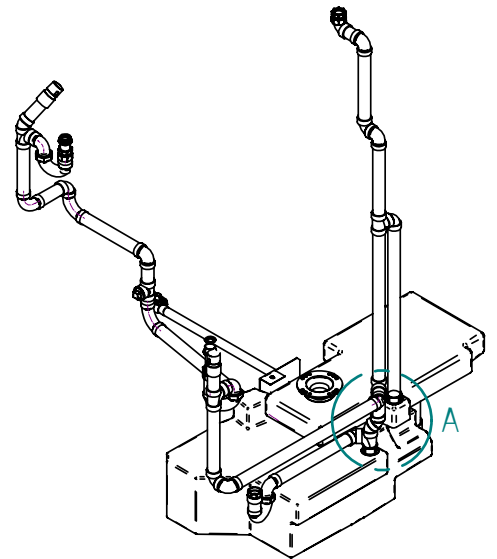
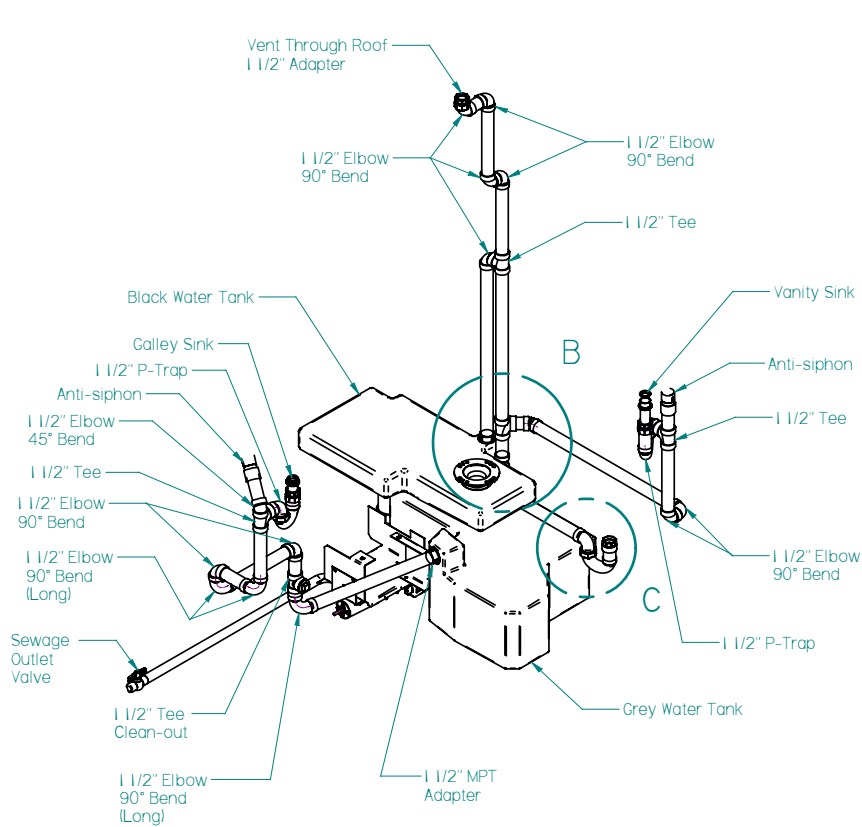
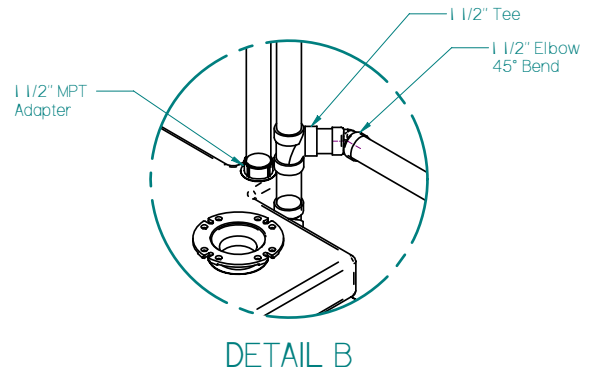
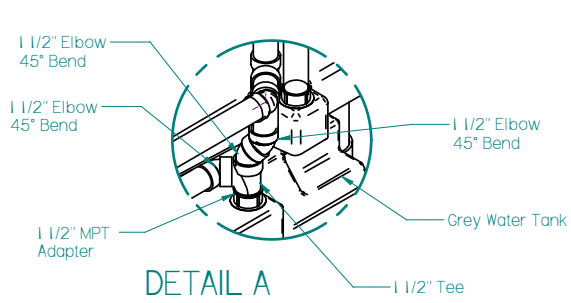

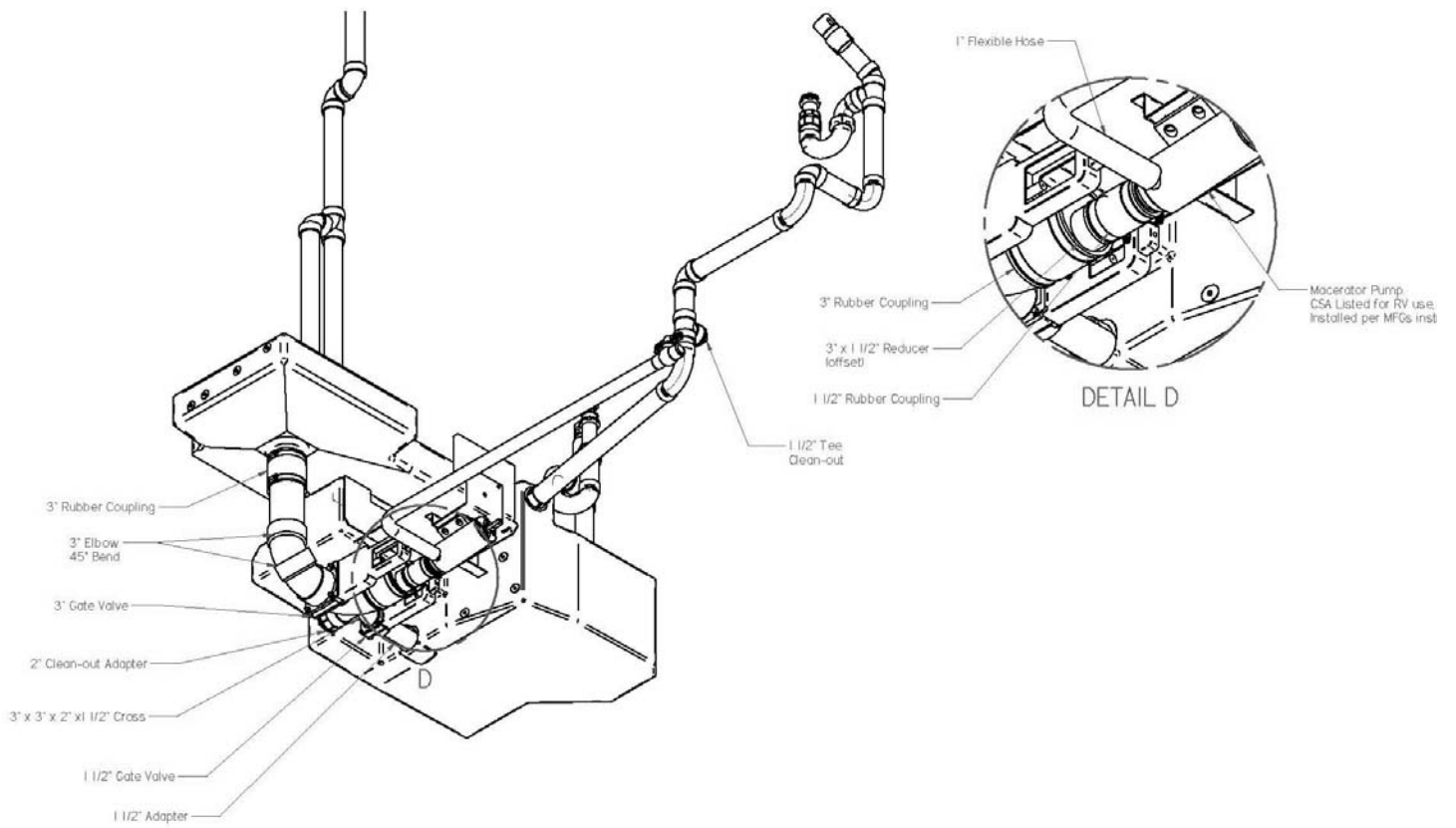

Tire Fundamentals:

Federal law requires tire manufacturers to place standardized information on the sidewall of all tires. This information identifies and describes the fundamental characteristics of the tire and also provides a tire identification number for safety standard certification and in case of a recall. See diagram H-P1 for an example.

P

The "P" indicates the tire is for passenger vehicles.

Next number

This three-digit number gives the width in millimeters of the tire from sidewall edge to sidewall edge. In general the larger the number, the wider the tire.

Next number

This two-digit number, known as the aspect ratio, gives the tire's ratio of height to width. Numbers of 70 or lower indicate a short sidewall for improved steering response and better overall handling on dry pavement.

R

The "R" stands for radial. Radial ply construction of tires has been the industry standard for the past 20 years.

Next number

This two-digit number is the wheel or rim diameter in inches. If you change your wheel size, you will have to purchase new tires to match the new wheel diameter.

Next number

This two- or three-digit number is the tire's load index. It is a measurement of how much weight each tire can support. You may find this information in your owner's manual. If not, contact a local tire dealer. Note: You may not find this information on all tires because it is not required by law.

M+S

The "M+S" or "M/S" indicates that the tire has some mud and snow capability. Most radial tires have these markings; hence, they have some mud and snow capability.

Speed Rating

The speed rating denotes the speed at which a tire is designed to be driven for extended periods of time. The ratings range from 99 miles per hour (mph)(Q) to 186 mph(Y or ZR). Note: You may not find this information on all tires because it is not required by law.

U.S. DOT Tire Identification Number

This begins with the letters "DOT" and indicates that the tire meets all federal standards. The next two numbers or letters are the plant code where it was manufactured, and the last four numbers represent the week and year the tire was built. For example, the numbers 3197 means the 31st week of 1997. The other numbers are marketing codes used at the manufacturer's discretion. This information is used to contact consumers if a tire defect requires a recall.

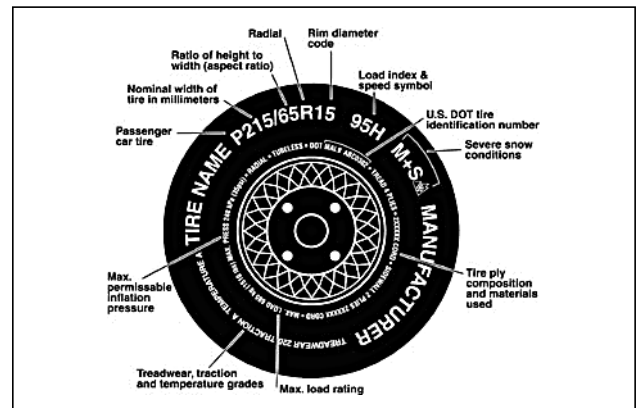

Picture H-P1: Information on passenger vehicle tires

Tire Ply Composition and Materials Used

The number of plies indicates the number of layers of rubber-coated fabric in the tire. In general, the greater the number of plies, the more weight a tire can support. Tire manufacturers also must indicate the materials in the tire, which include steel, nylon, polyester, and others.

Maximum Load Rating

This number indicates the maximum load in kilograms and pounds that can be carried by the tire.

Maximum Permissible Inflation Pressure

This number is the greatest amount of air pressure that should ever be put in the tire under normal driving conditions.

UTQGS Information

Tread Wear Number

This number indicates the tire's wear rate. The higher the tread wear number is, the longer it should take for the tread to wear down. For example, a tire graded 400 should last twice as long as a tire graded 200. See diagram H-P2 for an example.

Traction Letter

This letter indicates a tire's ability to stop on wet pavement. A higher graded tire should allow you to stop your car on wet roads in a shorter distance than a tire with a lower grade. Traction is graded from highest to lowest as "AA," "A," "B," and "C".

Temperature Letter

This letter indicates a tire's resistance to heat. The temperature grade is for a tire that is inflated properly and not overloaded. Excessive speed, under inflation or excessive loading, either separately or in combination, can cause heat build-up and possible tire failure. From highest to lowest, a tire's resistance to heat is graded as "A," "B," or "C".

LT

The "LT" indicates the tire is for light trucks.

Max. Load Single kg,(lbs) at kPa,(psi) Cold

This information indicates the maximum load and tire pressure when the tire is used as a single.

Load Range

This information identifies the tire's load-carrying capabilities and its inflation limits.

Snow Tires

In some heavy snow areas, local governments may require true snow tires, those with very deeply cut tread. These tires should only be used in pairs or placed on all four wheels. Make sure you purchase snow tires that are the same size and construction type as the other tires on your vehicle.

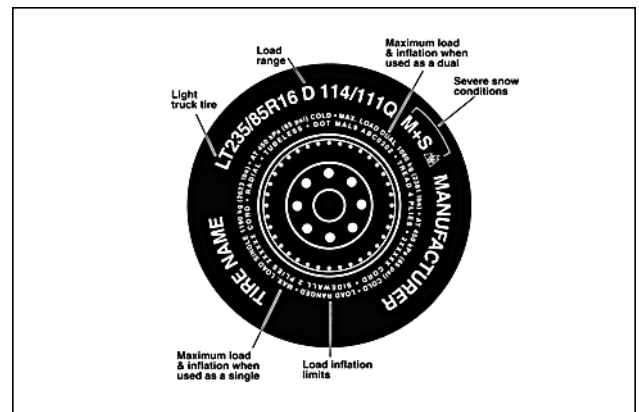

Picture H-P2: Additional Information on Light Truck Tires

EXTERIOR WASHING:

To prevent water from entering your vehicle, avoid spraying water directly into exterior vents or grills. Use care and caution when using a power washer to prevent water leaks. Do not point power washer directly towards any door openings, body seams, vents or any automotive striping.

OTHER MAINTENANCE:

For necessary maintenance of other components and appliances, see their respective manufacturer's owner's manuals for instructions.

WINTER STORAGE:**INSIDE YOUR VEHICLE:**

Before winter storage:

1. Be sure to clean your vehicle thoroughly. Special emphasis should be given to the appliances, such as the refrigerator.
2. Once cleaned, leave the refrigerator door propped open with the cutting board in the freezer compartment to prevent the development of odors, (insert a box of baking soda if desired).
3. Open a window slightly allowing sufficient air circulation to avoid the development of odors, condensation and mildew.
4. To prevent sun, (ultraviolet) rays from deteriorating and fading interior fabrics, cover all upholstered seats and cushions. As a further precaution, close all curtains or blinds tightly.
5. Disconnect the auxiliary battery, using the disconnect switch located in the monitor panel.

OUTSIDE YOUR VEHICLE:

Before winter storage:

1. Ensure that all waste water tanks have been dumped and flushed, and that the entire potable water system has been properly drained, refer to sections on Potable Water System Draining and Potable Water System Winterizing.
2. Be sure to cover the external vents to the refrigerator, exhaust fan, furnace and air conditioner with heavy plastic sheeting to prevent entry by rodents and insects.
3. To improve tire life and maintain performance, put your vehicle up on blocks. Also, cover all tires that will be exposed to the sun light to prevent deterioration from ultraviolet rays.
4. Consult your automotive owner's manual or local automotive dealer regarding the steps necessary to prevent engine and chassis damage during long periods of storage in your particular region.
5. Vehicle should be parked level, so that all vents and water drains can operate properly.

SPRING START UP:

After storage, reactivate your vehicle for use by reversing all the procedures that you performed to prepare it for winter storage. In addition, the propane system's connections and fittings should be inspected for possible leaks, (by a certified propane installer) and all other systems and appliances should be operated to ensure satisfactory performance.

TIRES:

See the Dodge automotive chassis manufacturer's owner's manual and documents for tire warranty and recommended inflation pressures.

CARGO CARRYING CAPACITY:

See the information labels attached to the driver door post, inside of lower galley cabinet door, and the insert in the front of this manual.

OWNER MAINTENANCE CHECKS:

Listed below are vehicle maintenance checks and inspections that should be performed by the owner or qualified service technician at the indicated intervals.

Any adverse conditions should be brought to the attention of your dealer or qualified service technician for expert service advice as soon as possible.

The owner maintenance checks are generally not covered by warranties and you may be charged for labor, parts and supplies used.

WHEN YOU STOP FOR FUEL:

Extinguish all pilot lights, (e.g. refrigerator, furnace) , and ensure that the water heater is turned off.

Check the chassis engine oil level.

Look for low or under inflated tires, (refer to the chassis owners manual for tire pressure recommendations).

AT LEAST MONTHLY:

Check the chassis coolant level in the coolant recovery reservoir.

Check operation of all exterior lamps, including brake lamps, turn signals and hazard warning flashers.

Check the tire pressure.

Run the generator for 20 minutes, (under a load ie: running the heatpump/A/C) to keep engine parts lubricated and check that the generator is working correctly.

AT LEAST ONCE EVERY THREE MONTHS:

Flush the black water holding tank.

Flush the grey water holding tank.

Flush and sanitize the fresh water tank.

AT LEAST TWICE A YEAR:

- Check the power steering fluid level.
- Check the windshield washer fluid level and wiper operation. Clean wiper blades with clean cloth dampened with washer fluid.
- Check the radiator, heater and air-conditioning hoses for leaks or damage.
- Check for worn tires and loose wheel lug nuts.
- Check the parking brake system for proper operation.
- Check the head lamp alignment.
- Check the lap and shoulder seat belts for wear and proper function.
- Check the air pressure in the spare tire, (80 psi).
- Inspect all of the appliance vents to ensure they are free from dirt, insects, spider webs and/or nests.
- Inspect the black and grey water tank vent for any blockage.
- Clean the air conditioner filter.

AT LEAST ONCE A YEAR:

- Lubricate all of the exterior door hinges, locks and latches.
- Clean the battery terminals, (automotive and coach).
- Have propane test completed by a certified gas technician.
- Have appliances tested and cleaned.
- Wax & polish and protect exterior surfaces.

The above maintenance schedule is a recommendation only. Please refer to your Dodge Owners Manual for details on the Dodge required maintenance schedule.

Efficient economical vehicle performance will be enhanced by utilizing this recommended maintenance. It is strongly recommended that no repairs be made without appropriate training, tools and safety equipment. This could cause bodily injury, damage to the vehicle or cause the vehicle to operate improperly.

Home & Park shall not be held liable or assume any obligations or responsibilities whatsoever for any loss, damage or injury directly or indirectly caused by, arising or resulting from, or as a consequence of the use or nonuse of the information contained herein or the operation or non-operation of any items mentioned herein. Home & Park shall be indemnified and saved from all losses, expenses, claims and demands whatsoever.

AUXILIARY BATTERY:

Your vehicle is equipped with a group 27 lead acid auxiliary battery. Dual battery option is equipped with two 6 volt deep cycle batteries. It is recommended that the acid levels in the battery(s) be inspected at least once every 3 months, and every 1 month under heavy usage.

See battery manufacturers maintenance recommendations.

ALUMINUM WHEEL MAINTENANCE:

Never clean your wheels when they are hot, either from free standing in the sun, or from normal road use.

Always clean your wheels when they are cool to the touch of your hand. If you spray any type of cleaning agent, corrosive or not on hot wheels, they will stain polished and chrome wheels and even some clear coated wheels.

Period. No matter how expensive they are.

Clean your wheels, either early in summer mornings or at dusk on summer evenings. A good practice is not to clean them in direct sunlight. We are experiencing different UV and ambient temperatures, from a result of a changing ozone. This also plays havoc on tires as well.

Clean the wheels using mild soap and water. Some strong cleaning agents will spot polished wheels every time.

Avoid car washes if possible when your wheels are hot. This could stain your wheels.

In time, due to brake and regional temperatures in North America, the wheel's lustre will fade, so from time to time, use a premium wheel cleaner/polish to keep the natural polished finish.

Never use steel wool or coarse abrasive pads to clean ANY wheel. This will cause permanent damage, and will not be warranted by the wheel manufacture.

It is recommended to use Vaseline, or some type of oil based cooking grease to coat the wheels during the harsh winter months and touch them up from time to time or have a set of winter wheels and tires.

LIMITED WARRANTY DEFINITIONS

Home & Park Home & Park Motorhomes, (A Division of HANMAR MOTOR CORPORATION).

Dealer	Dealer or any wholesale buyer of recreational vehicles, authorized by Home & Park .
Vehicle	Any recreational vehicle manufactured by Home & Park Motorhomes .
Purchaser	Registered owner of the Vehicle and/or purchaser of the Vehicle .
Warranty Card	Home & Park Limited Warranty Registration Card specifying Purchaser of Vehicle .

All vehicles are covered by a three part limited warranty: Automotive Warranty, Appliance Warranty, and Home & Park Limited Motorhome Warranty.

HOME & PARK LIMITED WARRANTY REGISTRATION

It is very important that the Dealer complete the Home & Park Limited Warranty Registration, (at the bottom of the "QualityCare" Pre-Delivery Report) **on each Vehicle and fax it to Home & Park within 48 hours from the date of retail delivery.** Home & Park uses the information on the Limited Warranty Registration to:

1. Notify DaimlerChrysler to start the automotive, (chassis) warranty in the Purchaser's name as of the date of retail delivery.
2. Maintain records for the Home & Park Limited Motorhome Warranty and for any recall notifications.

If Home & Park doesn't receive this information, when the Purchaser tries to have automotive warranty work done, the Purchaser, the Dealer and Home & Park will be severely inconvenienced until this information is received and processed by DaimlerChrysler.

AUTOMOTIVE WARRANTY - DAIMLERCHRYSLER, (SPRINTER CHASSIS)

The warranty currently offered by DaimlerChrysler covers the manufacture of the Sprinter chassis. Although the Purchaser will receive the full time period of the warranty, such warranty does not make an allowance for the miles on the odometer at the date of retail delivery ?? In other words, the warranty ends when the odometer reading reaches the limit as specified by the selected warranty, regardless of the odometer reading at the date of retail delivery. See the Sprinter Warranty Information booklet for details.

For Sprinter chassis sold through RV dealers, Home & Park uses the information on the completed Warranty Card to notify DaimlerChrysler to restart the automotive warranty in the Purchaser's name as of the date of retail delivery. Upon receipt of the Warranty Card, Home & Park completes and mails the appropriate forms to DaimlerChrysler who in turn enters this information into its computer system (please allow 8 to 12 weeks for this information to be processed and appear on its computer system). If warranty work is required before this process is completed and the Vehicle's V.I.N. number appears on the DaimlerChrysler dealers computer, the Purchaser should ask the DaimlerChrysler dealer to enter the Purchaser's name and address and date of retail delivery into the computer. To prove the vehicle is still under warranty, the Purchaser should show a copy of the bill of sale to the DaimlerChrysler dealer.

If Home & Park doesn't receive the completed Warranty Card, when the Purchaser tries to have automotive warranty work done, the Purchaser, the Dealer and Home & Park will be inconvenienced until this information is received and processed by DaimlerChrysler.

For Sprinter chassis sold through DaimlerChrysler dealers, the Dealer will enter the appropriate information directly into DaimlerChrysler's computer system to restart the automotive, (chassis) warranty in the Purchaser's name as of the date of retail delivery.

All automotive service, maintenance and repairs are to be performed by any DaimlerChrysler, Sprinter or Plymouth dealer. See the DaimlerChrysler Warranty Information booklet for details. Such items are not warranted by Home & Park. Home & Park will pay for the removal and reinstallation of motorhome components necessary to perform automotive recalls and warranty for 36 months or 36,000 miles, (in US) or 60,000 Km, (in Canada), which ever occurs first, from date of purchase by the first Purchaser. After this period such costs are considered to be inherent in the ownership of such a vehicle. Home & Park will not pay for the removal and reinstallation of motorhome components necessary to perform automotive service or maintenance. Such costs are considered to be inherent in the ownership of such a vehicle.

AUTOMOTIVE CUSTOMER SERVICE & ROADSIDE ASSISTANCE NUMBERS

Chrysler, (US) customer service	800-992-1997
Chrysler, (US) roadside assistance	800-521-2779
Chrysler, (Canada) customer service	800-465-2001
Chrysler, (Canada) roadside assistance	800-363-4869

APPLIANCE WARRANTY

Appliances are not warranted by Home & Park, but are covered by individual warranties offered by their respective manufacturers to which terms both Purchaser and Dealer must comply: air conditioner, electrical inverter/charger, furnace, generator, microwave oven, refrigerator, stove, toilet, water pump, macerator and water heater. Home & Park makes no warranty whatsoever, regarding these items and/or such like components manufactured by others. However, Home & Park will pay for the removal and reinstallation of such components that it determines at its sole discretion are installed by Home & Park in a manner unusual to the industry. **Purchaser and/or Dealer are required to deal directly with the nearest service center for such manufactured components** and abide by the warranty policy as allowed by such component manufacturers.

HOME & PARK LIMITED MOTORHOME WARRANTY:

Home & Park warrants to the Purchaser that the Vehicle is free from defects in material and workmanship on the portion manufactured by Home & Park, under normal use and service, for **four, (4) years or 48,000 miles, (U.S.) or 80,000 Km, (Canadian)** whichever occurs first, from date of purchase by the first Purchaser or the date the Vehicle was first put into service, (for example, as a demo or rental), whichever is earlier.

This warranty shall be fulfilled at a Home & Park Dealer or authorized Roadtrek repair facility. For in transit emergency repairs, you may choose to deal with a non-authorized RV service facility. However **all warranty repairs at non-authorized RV service facilities** must be preauthorized by Home & Park. Home & Park will, at its option, replace or repair free of charge, (including related labor) any defective part, about which the Purchaser shall notify their Roadtrek Dealer within the warranty period. The obligation of Home & Park under this warranty, is expressly limited to such replacement or repair.

The provisions of this limited warranty shall not apply to the following:

1. Accident.
2. Unauthorized repairs or alterations.
3. Normal maintenance.
4. Changes made to other units manufactured after this Vehicle was manufactured.
5. Incidental damages connected with the failure of the Vehicle such as lost time, inconvenience, loss of use of the Vehicle, cost of rental cars, gasoline, telephone, travel or lodging.
6. Damages caused by environmental factors including, but not limited to, hailstorms, tornadoes, sandstorms, lightning, floods, earthquakes, airborne fallout, chemicals, tree sap, ocean spray, road hazards.
7. Vehicle that has been declared a total loss by an insurance company, (demolished) or a Vehicle whose title indicates that it is designated as "salvage," "junk," or "rebuilt" or words of similar impact.
8. Exterior side storage compartments may not be moisture free. It is advised that you store items accordingly. Home & Park is not responsible for goods damaged while stored in exterior storage compartments.
9. There will be no allowance for emergency road repair, towing, labor, meals accommodations, etc. Such will not be accepted if claimed under warranty.
10. After the "QualityCare" Pre-Delivery Report is completed by the dealer, appliance adjustments, door latch adjustments, light bulbs, fuses, battery in the smoke detector and window screens are warranted for 90 days.
11. Aluminum wheels are not warranted against corrosion that is a result of road salt, sea salt, cleaning chemicals or harsh driving conditions.

HOME & PARK LIMITED MOTORHOME WARRANTY:

The provisions of this limited warranty shall not apply to deterioration due to wear and exposure beyond the following limitations:

1. For **one, (1) year** or 12,000 miles, (in US) or 20,000 Km, (in Canada), which ever occurs first, from date of purchase by the first Purchaser for sewage hose, curtain fabric, seating fabric, carpet, cup holders, exterior stripes and decals, running board trim, and black and grey water tank gate valves.
2. For **two, (2) years** or 24,000 miles, (in US) or 40,000 Km, (in Canada), which ever occurs first, from the date of purchase by the first Purchaser for leather seats.
3. For **three, (3) years** or 36,000 miles, (in US) or 60,000 Km, (in Canada), which ever occurs first, from date of purchase by the first Purchaser for exterior painted surfaces.

Home & Park Limited Motorhome Warranty is void unless the following conditions are adhered to:

1. Warranty Card for your Vehicle must be completed by your Dealer and faxed to Home & Park Motorhomes within 48 hours of the date of retail delivery. When warranty applications are made and the Warranty Card is not on file at Home & Park, reimbursement of the claim will be delayed until proof of original purchase is submitted to Home & Park.
2. All warranty claims must be submitted on a Home & Park Motorhomes Warranty Claim form and properly completed including Vehicle Identification Number, (V.I.N.), odometer reading and Home & Park Limited Motorhome Warranty start date, (date of retail delivery).
3. **Warranty work that will exceed \$200.00 must first be authorized by Home & Park before proceeding with such repair work.** The authorization number issued by Home & Park must be noted on the warranty claim form in the top right hand corner.
4. Home & Park reserves the right to inspect defective parts that have been replaced under warranty. Dealer is expected to hold selected parts for a period of not to exceed 60 days.
5. Only parts and accessories and other material, available through Home & Park are to be used in the performance of warranty service.
6. Warranty repairs performed a second time by a Dealer, (due to incorrect or inadequate diagnosis, improper assembly or repair, or lack of proper testing when the original warranty repair was performed) are considered as shop comebacks and are not reimbursable. Costs of such repairs must be adsorbed by the Dealer.
7. All claims must be submitted within 30 days of the date of repair.
8. Purchasers are responsible for presenting their vehicle to a Roadtrek Dealer as soon as a problem exists. The warranty repairs should be completed in a reasonable amount of time from date of authorization from Home and Park.

This limited warranty is expressly in lieu of any other expressed or implied warranty, including any implied warranty of merchantability or fitness for a particular purpose and of any other obligations or liabilities on Home & Park which neither assumes nor authorizes any other person to assume for it any other liability in connection with Vehicle manufactured by it.

REPORTING SAFETY DEFECTS, (U.S. ONLY)

If you believe that your vehicle has a defect which could cause a crash or could cause injury or death, you should immediately inform the National Highway Traffic Safety Administration, (NHTSA) in addition to notifying Home & Park.

If NHTSA receives similar complaints, it may open an investigation, and if it finds that a safety defect exists in a group of vehicles, it may order a recall and remedy campaign. However, NHTSA cannot become involved in individual problems between you, your dealer, or Home & Park.

To contact NHTSA, you may call the Auto Safety Hot line toll-free at 1-888-327-4236, (TTY: 1-800-424-9153), (or 366-0123 in Washington, DC area) or write to:

NHTSA
400 Seventh St., S.W.,
Washington, DC 20590

You can also obtain other information about motor vehicle safety from the Hot line.

ROADTREK AMBASSADOR POTENTIAL CUSTOMER REFERRAL PROGRAM FOR ROADTREK OWNERS:

Most Roadtrek owners spend a lot of their valuable time giving tours of their Roadtreks to numerous inquisitive people. Many of these potential customers become Roadtrek owners. To reward their efforts and encourage more "tours" by these very convincing "sales people," we will pay a \$100.00 commission and provide incentive rewards to any Roadtrek owner who refers a potential customer to us who eventually purchases a new Roadtrek.

To participate in this program, the Roadtrek owner must sign up for the Roadtrek Ambassador program by visiting www.roadtrek.com/ambassador or calling 1-888-ROADTREK, (762-3873). For every potential customer that you show your Roadtrek, complete a "Potential Customer Referral Card". You will receive \$100.00 for each referral that purchases a new Roadtrek. In addition, we have these complimentary gifts:

1. For your 1st purchasing customer we will send you Two Roadtrek Ambassador Golf Shirts.
2. For your 2nd purchasing customer we will send you Two Roadtrek Ambassador Windbreakers.
3. For your 5th purchasing customer we will send you Two Roadtrek Ambassador Leather & Melton jackets.
4. For your 10th purchasing customer we will provide an all expense paid trip to the Roadtrek factory.

If these incentives weren't enough, all Roadtrek Ambassadors referring more than 2 purchasing customers in a given year will be eligible for a draw to win the use of a new Roadtrek for a full year, (mileage restrictions will apply).

This program is subject to the following conditions:

1. Home & Park receives a "Potential Customer Referral Card", (supplies available upon request) completed and mailed by the potential customer and/or Roadtrek owner.
2. The potential customer purchases a new Roadtrek within 3 years from the date the "Potential Customer Referral Card" is received by Home & Park.
3. The potential customer purchases a new Roadtrek and has the dealer complete the "Home & Park Warranty Registration" in the same name and address that was inserted on the "Potential Customer Referral Card".
4. If more than one Roadtrek owner refers the same potential customer, the \$100.00 commission will be split equally among all of the referring Roadtrek owners.

Home & Park Motorhomes reserves the right to cancel this program based upon 90 days notice to Roadtrek owners.

ROADTREK CLUB INTERNATIONAL

As a new Roadtrek owner, you are cordially invited to join our family of Roadtrek owners as members of the "Roadtrek Club International". An owners' club offers its members an opportunity to meet other people with common interests, attend enjoyable gatherings, (such as group outings, sight seeing, camping, suppers, factory tours, and more!), share travel experiences, keep current on the latest information and products from the factory, and exchange ideas for improvements or solutions to problems. Annual membership dues are only US\$10. Their common bond is the that they are all Roadtrek owners. As a group, they promote fellowship and enrich their way of life.

Roadtrek Club International is an active Chapter of the Family Motor Coach Association. FMCA, the foremost organization in the world composed exclusively for motorhome owners, was founded in 1963 for the express purpose of promoting fellowship and the use of motor coaching for pleasure. Many of its 130,000 members meet and form fast friendships with fellow motorhomers and join together in Association sponsored activities that are interesting and fun.

FMCA offers benefits and services specially designed to meet the needs of motorhome owners that you can't get anywhere else. Although space does not permit listing everything available, member benefits include: free monthly subscription to the full color Family Motor Coaching magazine, minimum cost motorhome insurance, accidental death coverage, emergency road service, trip routing service, toll free 800 number message service, mail forwarding, identification emblems for your motorhome, free membership directory, anti-theft program, discount programs, national and regional conventions, caravans and tours, and year-round activities in nearly 300 chapters of FMCA for fun, fellowship and entertainment... plus much more. FMCA dues are \$35 per year plus a one time \$10 initiation fee in the first year.

Just complete the applications on the next page and mail them with your checks to the addresses shown. You'll be glad you did!

ADDRESS, PHONE & FACSIMILE NUMBERS, AND E-MAIL

Address all inquiries to: Home & Park Motorhomes
Warranty & Service Department
100 Shirley Avenue
Kitchener, Ontario, Canada, N2B 2E1
Telephone: toll free 888-ROADTREK, (762-3873) or 519-745-1169
Facsimile: 519-745-1160
E-mail: service@roadtrek.com

All inquiries must include: Owner's name, address, home and work phone numbers
Selling Home & Park dealer's name and contact
Servicing Chevrolet dealer's name, contact and phone number,
(if applicable)
Last 8 digits of Vehicle Identification Number, (V.I.N.)
Vehicle mileage
Date of Retail Delivery

WEBSITE

Checkout the Roadtrek website at www.roadtrek.com

ROADTREK INTERNATIONAL CHAPTER FMCA A ROADTREK OWNERS' CLUB

Please Print **MEMBERSHIP APPLICATION** **Date** _____

Last Name _____ First Name _____ Spouse _____

Address _____ City _____ Prov/State _____

Country _____ Postal/ZIP Code _____ Phone: () _____

FMCA# _____ If you are not currently a member of the Family Motor Coach Association, please complete the FMCA Membership Application Form below. **WE CANNOT PROCESS YOUR ROADTREK INTERNATIONAL CHAPTER APPLICATION UNTIL YOU ARE AN FMCA MEMBER.** Mail both forms and checks in separate envelopes today. FMCA members send only the Roadtrek application form and check.

I/We would be interested in helping run the Chapter. _____ Yes _____ No

I/We would be interested in serving as an elected officer. _____ Yes _____ No

Please enclose \$10.00 in U.S. funds. Note: The Chapter cannot accept credit cards.

Make check or money order payable to **“Roadtrek International”**.

Mail application and fee to: *Becky Hartley, Chapter Treasurer, Email: johnbeckyhartley@sbcglobal.net
231 W. Washington St. Nelsonville, OH 45764-1138 Telephone: (740) 753-1066*



[Cut and mail in separate envelopes]

FAMILY MOTOR COACH ASSOCIATION

Please Print **MEMBERSHIP APPLICATION** **Date** _____

Last Name _____ First Name _____ Spouse _____

Address _____ City _____ Prov/State _____

Country _____ Postal/ZIP Code _____ Phone: () _____

E-mail Address _____ **Coach Manufacturer:** Home & Park Motorhomes

Model: _____ *Roadtrek* **Year:** _____ **Length:** _____ **License Plate Number:** _____

I have applied for membership in the **Roadtrek International Chapter** of the Family Motor Coach Association.

() If you are a former member, check here.

Occupation or former occupation, if retired.

How did you hear about FMCA?

If referred by an FMCA member, please list his/her name and member number

I enclose \$45, (payable in U.S. funds) for a Full/Family membership, (includes membership identification emblems.). The \$45 is composed of a \$10 initiation fee, \$30 for one year's membership fee, and \$5 for a one-year subscription to *Family Motor Coaching* magazine. I understand that upon acceptance of my application, I will be sent a copy of the FMCA Code of Ethics. I agree to read and abide by this code, which represents all our endeavors to be good neighbors, careful and responsible coach owners and operators, and good citizens of our communities.

Signed: _____

Make check or money order payable to: FMCA, Inc.

Please charge my

Mastercard VISA Discover American Express

Card # _____ Exp. Date _____

Signature. If charged, must sign here.



Return application and fees to: FMCA Membership Chairman, 8291 Clough Pike, Cincinnati, OH 45244-2796. Telephone (513) 474-3622



CHANGE OF OWNER NAME OR ADDRESS FORM

IMPORTANT - To owner with New Address or Used-Vehicle Buyer -
complete and mail for accuracy of recall mailing records.

PLEASE TYPE OR PRINT LEGIBLY:

1. VEHICLE IDENTIFICATION NUMBER (17 character number found on top left of instrument panel)										
2. PRINT Last Name (including Jr., Sr., etc.)										
3. PRINT First Name (or Initial) and Middle Name (or Initial)										
4. PRINT NEW mailing Address: House/Building Number and Street Name (including St., Ave., Rd., Ct., etc.)										
Apt./Suite No.		or	P.O. Box No.			or <input type="checkbox"/> RR/ <input type="checkbox"/> HCR (check one)		<input type="checkbox"/> RR/ <input type="checkbox"/> HCR Box No.		
City				State		ZIP Code		ZIP + 4		
Area Code				Prov.		Postal Code				
Phone No.		Month	Day	Year		Email Address				
Current Date		Month	Day	Year		Email Address				



Form 2, February 1999
M190204



**AFFIX
STAMP**

100 SHIRLEY AVENUE
KITCHENER, ONTARIO
N2B 2E1



POTENTIAL CUSTOMER REFERRAL CARD

PLEASE TYPE OR PRINT LEGIBLY:

PRINT **Potential Customer Name** (including Jr., Sr., etc.)

PRINT **Mailing Address:** House/Building Number and Street Name (including St., Ave., Rd., Ct., etc.)

City State/Prov. ZIP/P.C.

Country Email

Please send me a brochure and the name and address of my nearest dealer

REFERRED BY: Area Code

Roadtrek Vehicle Identification Number (last 8 digits only) Phone No. | | - | | |

PRINT **Roadtrek Owner's Name** (including Jr., Sr., etc.)

Optional

PRINT **Mailing Address:** House/Building Number and Street Name (including St., Ave., Rd., Ct., etc.)

City State/Prov. ZIP/P.C.

Email

Please send me more of these referral cards

Please send me more brochures

by Home & Park Motorhomes M300404



POTENTIAL CUSTOMER REFERRAL CARD

PLEASE TYPE OR PRINT LEGIBLY:

PRINT **Potential Customer Name** (including Jr., Sr., etc.)

PRINT **Mailing Address:** House/Building Number and Street Name (including St., Ave., Rd., Ct., etc.)

City State/Prov. ZIP/P.C.

Country Email

Please send me a brochure and the name and address of my nearest dealer

REFERRED BY: Area Code

Roadtrek Vehicle Identification Number (last 8 digits only) Phone No. | | - | | |

PRINT **Roadtrek Owner's Name** (including Jr., Sr., etc.)

Optional

PRINT **Mailing Address:** House/Building Number and Street Name (including St., Ave., Rd., Ct., etc.)

City State/Prov. ZIP/P.C.

Email

Please send me more of these referral cards

Please send me more brochures

by Home & Park Motorhomes M300404



**AFFIX
STAMP**

 **Roadtrek**™®
100 SHIRLEY AVENUE
KITCHENER, ONTARIO
N2B 2E1



**AFFIX
STAMP**

 **Roadtrek**™®
100 SHIRLEY AVENUE
KITCHENER, ONTARIO
N2B 2E1

Please contact Home & Park Motorhomes should you require additional customer referral cards.



Division of HANMAR MOTOR CORPORATION

100 Shirley Avenue, Kitchener, Ontario,
Canada, N2B 2E1

Telephone: 519-745-1169

or Toll Free 1-888-ROADTREK (1-888-762-3873)

Telefacsimile: 519-745-1160

Email: service@roadtrek.com

WebSite: <http://www.roadtrek.com/LIT>